

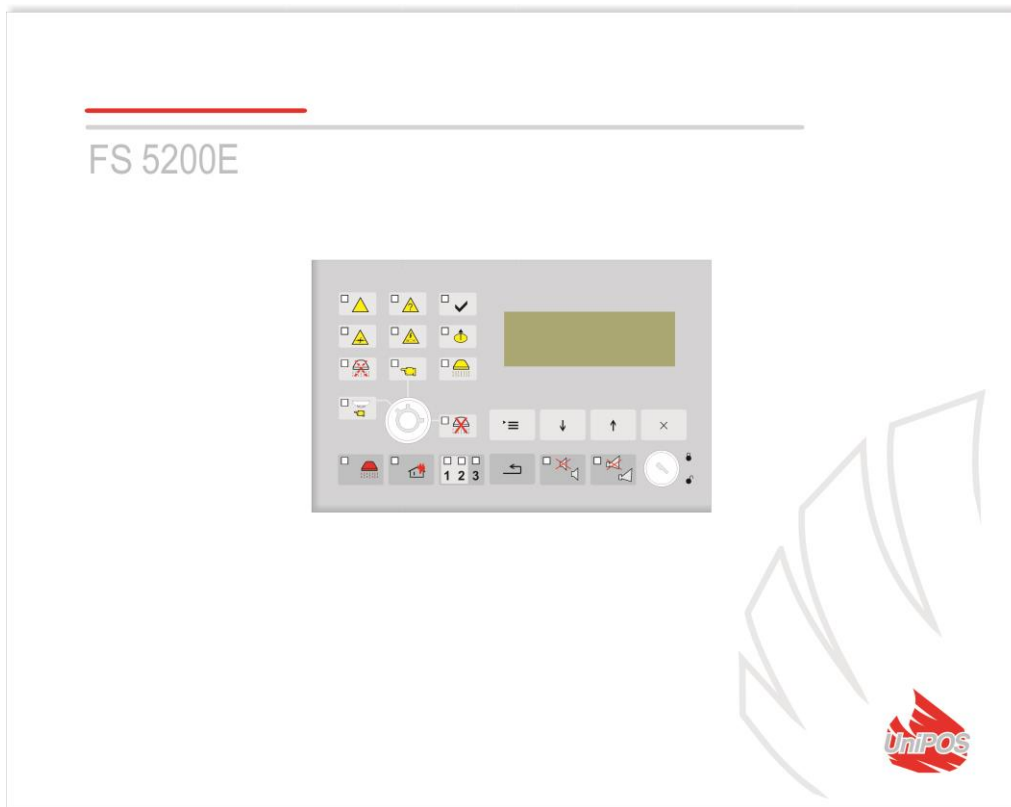

# Fire Extinguishing Control Panel FS5200E

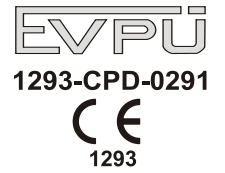

## INSTRUCTION MANUAL

Revision 8/01.17

## Table of contents

<a href="#">1.</a>	Terminology .....	4
<a href="#">2.</a>	Technical Data.....	6
<a href="#">3.</a>	Contents of Delivery.....	8
<a href="#">4.</a>	Installation and Arrangements.....	8
4.1.	To Mount the Control Panel.....	8
4.2.	Description of Inputs and Outputs. Periphery Devices Assembly .....	8
4.2.1.	Description and Mounting of Devices to L1, L2 and L3 Inputs.....	11
4.2.2.	Description and Mounting of Devices to Manual Release Input .....	12
4.2.3.	Description and Mounting of Devices Mode Select Input .....	12
4.2.4.	Description and Mounting of Devices Hold Input .....	13
4.2.5.	Description and Mounting of Devices On/Off Exting Input .....	13
4.2.6.	Description and Mounting of Devices Low Press Input .....	14
4.2.7.	Description and Mounting of Devices Exting Output .....	14
4.2.8.	Description and Mounting of Devices Sounder S1 and Sounder S2 Outputs .....	15
4.2.9.	Description and Mounting of Devices to Outputs OK1, OK andи OK3 Open Collector Type.....	15
4.2.10.	Description and Mounting of Devices to Rel Fire Output.....	15
4.2.11.	Description and Mounting of Devices Rel 1 <sup>ST</sup> and Rel 2ST Outputs .....	16
4.2.12.	Description and Mounting of Devices to Rel Fault Output .....	16
4.2.13.	Description and Mounting of Devices to RS485 Interface Terminals.....	16
4.3.	Power Supply Connection .....	16
<a href="#">5.</a>	General Information .....	17
5.1.	Access Levels .....	17
5.2.	Indications and Buttons for Control.....	18
5.3.	Conditions of the Fire Extinguishing Control Panel.....	20
<a href="#">6.</a>	Duty Mode .....	21
6.1.	Description.....	21
6.2.	Indication .....	21
6.3.	Using the Keypad .....	21
<a href="#">7.</a>	Fire Condition Stage I.....	21
7.1.	Description.....	21
7.2.	Indication.....	22
7.3.	Using the Keypad .....	22
<a href="#">8.</a>	Fire Condition Stage II .....	23
8.1.	Description.....	23
8.2.	Indication .....	23
8.3.	Using the keypad.....	25
8.4.	Using the Switch for Mode Selection (Automatic/Manual/Disabled).....	26
<a href="#">9.</a>	Fault Condition.....	26
9.1.	Description.....	26
9.2.	Indication.....	27
9.3.	Using the Keypad .....	28
<a href="#">10.</a>	Disabled Component .....	29
10.1.	Description .....	29
10.2.	Indication .....	29
10.3.	Using the Keypad .....	30
<a href="#">11.</a>	Test Mode .....	30
11.1.	Description.....	30
11.2.	Indication.....	30
11.3.	Using the Keypad .....	30
<a href="#">12.</a>	Information and Control Mode .....	31
12.1.	Description .....	31
12.2.	Indication .....	31
12.3.	Using the Keypad .....	31
12.4.	Using the Menus .....	32
12.4.1.	Menu View Faults .....	32

12.4.2.	Menu View Disables.....	33
12.4.3.	Menu View Test .....	34
12.4.4.	Menu Statuses .....	35
12.4.5.	Menu System Functions .....	36
<a href="#">13.</a>	Setup Mode .....	44
13.1.	Description.....	44
13.2.	Indication .....	45
13.3.	Using the Keypad .....	45
13.4.	Using the Menus .....	46
13.4.1.	Menu Fire Extinguishing Control Panel.....	46
13.4.2.	Menu „CAN Parameters”.....	48
13.4.3.	Menu Inputs/Outputs .....	54
13.4.4.	Menu Time Extinguishing.....	56
13.4.5.	Menu Time Evacuation.....	56
13.4.6.	Menu Factory Settings.....	57
13.4.7.	Menu Clear archive.....	57
13.4.8.	Menu new Password.....	57
<a href="#">14.</a>	Extinguishing Control Algorithm.....	57
<a href="#">15.</a>	Labour Protection Requirements .....	59
<a href="#">16.</a>	Fire Extinguishing Control Panel Start Up .....	59
<a href="#">17.</a>	Operation, Storage and Transportation .....	59
<a href="#">18.</a>	Warranty .....	59
<a href="#">19.</a>	Appendixes .....	60

## **Introduction**

The fire extinguishing control panel FS5200E is designated for fire protection, monitoring and control of systems for active extinguishing.

After processing the signals from the automatic fire detectors and/or manual call points the control panel it sends commands to the executive devices for extinguishing, sound-light signalers, air conditioning and ventilation devices, it sends information to a repeater, PC or another intelligent devices.

FS5200E could be used in – gas, powder, aerosol, water and other types of systems for active extinguishing.

The fire extinguishing control panel is designed for extinguishing in one zone. It is possible up to 15 zones to be protected when the fire extinguishing control panel is connected in a network via interface RS485 and a repeater FS5200R.

The fire extinguishing control panel could be connected and become a part of the Interactive Fire Control System IFS7002 /UniPOS production/.

The fire extinguishing control panel FS5200E is designed and produced in compliance with standards EN 54-2:1997/ A1:2006/AC: 2009, EN 54-4:1997/A2: 2006/AC: 2009, EN 12094-1: 2003.

Some of its main features and possibilities are:

- adjustment of operating modes and parameters of each fire alarm line, output and input via built in keypad;
- user oriented menu dialogue for easy and convenient operation;
- LCD for visualization of system checkup and set up modes;
- LEDs indication for early warning of a break down or extreme conditions;
- energy independent archive memory saving the event type, date and time, allowing for detailed analysis of the actions of the authorized personnel and of possible problems in the fire protection process of the area;
- user oriented test modes allowing for a total control of the site protected;
- built-in serial interface RS485 and CAN for connection to other fire control panels;
- compatible to random installation design, within the range of the available fire extinguishing control panels resources.

All these are realizable via fire extinguishing control panel's keypad and after a detailed examination of the instructions set herewith.

### **1. Terminology**

**OUTPUT** – *monitored or relay output*, programmed by the user to be activated during the different stages of the extinguishing.

**EVACUATION TIME** – the time from occurring the situation for extinguishing to the moment of switching on the extinguishing automatics. This time should be enough for the evacuation of the staff from the premises. The evacuation time is user defined for the specific site. The evacuation time is shown on the LCD display and it counts down the remaining time until the release of the extinguishing automatics.

**DISABLED LINE** – *the fire detecting line* is switched off (not power supplied) and it is not monitored for turned out fire detector and a fault condition. This feature is user defined. The indication for a disabled line is common light indication and text messages on the LCD display.

**DISABLED OUTPUT** – *the output* is switched off (the executive device can not be activated) and is not monitored for a fault condition in the monitored outputs. This feature is user defined. The indication for a disabled monitored output is common light indication and text messages on the LCD display.

**DISABLE EXTINGUISHING** – condition of the fire extinguishing control panel when regardless the input actions the executive extinguishing device cannot be activated. Disable extinguishing is

defined by “on” status of the monitored input “On/Off Exting” (See section 4.2.) or by the secret switch on the front panel. The indication for disable extinguishing is an individual light indication.

**HOLD EXTINGUISHING** – condition of the fire extinguishing control panel when the release signal to the executive extinguishing device is delayed. Hold extinguishing is defined by “on” status of the monitored input „Hold”. Hold extinguishing could be controlled by a manual button if extra evacuation time is needed and monitoring if the doors of the protected premise are tightly closed. After the hold signal is cancelled the timer for the evacuation time is started automatically. After the evacuation time expires the extinguishing executive device is switched on. The indication for hold extinguishing is an individual light indication.

**GROUNDINGS** – non-system *non-fatal fault condition*, due to leakage to a grounded wire.

**MONITORED INPUT** – input that monitors the serviceability of the connection wires between the fire extinguishing control panel and the executive devices. Follow the special diagram for connection. (See section 5.2.).

**MONITORED OUTPUT** – a potential output that monitors the serviceability of the connection wires between the fire extinguishing control panel and the executive device. Follow the special diagram for connection. (See section 5.2.).

**SHORT CIRCUIT IN A LINE, MONITORED OUTPUT OR MONITORED INPUT** – non-system, *non-fatal fault condition*, entered due to registered current value, exceeding a threshold value.

**LINE IN TEST** – a *line*, set in Test condition by the user. The line is switched on (supplied) and reset (the power supply is switched off for 3 s) periodically every 60 s. The events registered in a line in Test condition are not saved in the archive and do not trigger the outputs or the light and sound signaling. The indication for a line in Test condition is a text message in the display field for the respective line.

**LOCAL SOUNDER** – a sounder built-in the fire extinguishing control panel.

**NON-FATAL FAULT CONDITION** – fault condition that allows the fire extinguishing control panel to continue operation. The non-fatal fault condition is not usually a *system fault condition*. The indication is common light indication, local sound indication and text messages on the LCD display.

**ACCESS LEVEL** – access level to various indications and control functions (See section 5.1).

**LOW BATTERY** – non-system *fatal fault condition* due to full discharge of the backup batteries upon interrupted power supply.

**SUPPRESSED OUTPUT** – a *monitored or relay output*, which should be activated (for the respective Extinguishing stage) but it is switched off manually by the user.

**FIRE DETECTING LINE** (further in the text only **LINE**) – a combination of fire detectors, physically connected by two-wire connection. Maximum 32 fire detectors could be connected in each line.

**FIRE CONDITION STAGE I** – phase of Fire condition; upon activation of automatic fire detector only in one line the fire extinguishing control panel enters Fire condition. It continues until the line is manually reset by Reset Alarm. The indication for Fire condition stage 1 is common light indication. Local sound signaling and text messages on the LCD display.

**FIRE CONDITION STAGE II** – phase of Fire condition when active extinguishing procedure is started. The fire extinguishing control panel enters this stage in the event of:

- a) Fire condition along both fire detecting lines;

b) Manual button release for forced extinguishing.

The indication for Fire condition stage 1 is common light indication. Local sound signaling and text messages on the LCD display.

**INTERRUPTED LINE, MONITORED OUTPUT OR MONITORED INPUT** – non-system *non-fatal* fault condition entered when parameters lower than the threshold value are registered.

**RELAY OUTPUT** – a relay, potential-free switching outputs provided for controlling external executive devices.

**MANUAL RELEASE** – condition entered by the fire extinguishing control panel in the event of Fire condition stage II, regardless the status of the Fire detecting lines. The manual release is defined by “on” status of the monitored input „Manual Release”.

**MANUAL MODE** – condition when the fire extinguishing control panel could release the extinguishing devices only by manual release command. The manual mode is defined by “on” status of the monitored input „Mode Select”. The mode indication is an individual light indication.

**SYSTEM FAULT CONDITION** – fault condition due to a fault in the fire extinguishing control panel (system’s) component panel. The system fault condition could be *fatal* or *non-fatal*. The indication is common light indication, local sound indication and text messages on the LCD display.

**REMOVED FIRE DETECTOR /FD/** – non-system *non-fatal* fault condition entered when a removed fire detector in a *line* is registered. In order this function to be utilized follow the special diagram for connection (See section 5.2.).

**LINE STATUS, MONITORED OUTPUT OR MONITORED INPUT**– the current status of a *line*, *monitored output* or input: duty mode; fire condition (only for the fire detecting lines); fault condition (specifying the type of the fault condition).

**FATAL FAULT CONDITION** – fault condition that prevents the fire extinguishing control panel, or the part of it related to the communication with the user, from continuing its operation. The fatal fault condition is usually a *system* one, except *Law Battery* fault condition. The indication is common light indication, local sound indication and text messages on the LCD display.

## 2. Technical data

Fire detecting lines

- For extinguishing control - 2
- Without extinguishing control - 1
- Maximum number of fire detectors in a line - 32
- Type of the connecting line - two-wire
- Maximum resistance of a loop - 100Ω
- Output resistance of the line - 164Ω

### 2.1. Current thresholds in a line per default parameters for:

- ◆ 0÷3mA\* - interruption
- ◆ 3÷12mA\* - duty mode
- ◆ 12÷60mA\* - fire condition
- ◆ >80mA - short circuit

- \* It is possible the current in the lines for interruption, duty mode and fire condition to be adjusted (13.4.2.1.).

### 2.2. Monitored outputs for control the fire extinguishing control panel performance:

- Type - balanced
- 2.3. Monitored outputs for the sound-light indication**
- Type - potential relay
  - Electrical characteristics - (24±3)V/0.5 A
- 2.4. Monitored output for the extinguishing devices**
- Type - potential relay
  - Electrical characteristics - (24±3)V/1.5A
- 2.5. Relay outputs for common purpose**
- Type - potential free, switching
  - Electrical characteristics - 3A/125VAC; 3A/30VDC
- 2.6. Relay output for fault condition**
- Type - potential free, switching
  - Electrical characteristics - 3A/125VAC; 3A/30VDC
- 2.7. Relay output for fire alarm**
- Type - potential free, switching
  - Electrical characteristics - 3A/125VAC; 3A/30VDC
- 2.8. Performance characteristics**
- Control over the lines, the monitored inputs and outputs for fault condition (short circuit and interruption) and automatic reset
  - Control over the lines for removed fire detector and automatic reset
  - Ability to set the evacuation time
  - Ability to set the time when the extinguishing executive device is switched on
  - Built-in sounder for fire alarm first stage – one tonal, discontinuous, can be switched off
  - Built-in sounder for fire alarm second stage – one tonal, continuous, can be switched off
  - Built-in sounder for fault condition – one tonal, discontinuous, can be switched off
  - Built-in real time clock
  - Set of test modes and options for adjustment:
    - ◆ Setting the clock;
    - ◆ Check ups on light and sound indications;
    - ◆ Test of the fire detecting lines;
    - ◆ Adjustment of outputs and integrated external devices;
    - ◆ Current measurement in the fire detecting lines;
    - ◆ Programming of parameters and modes of operation;
    - ◆ Remote programming of the parameters from distant operator control point;
  - Energy independent archive of registered events by the fire extinguishing control panel with the events type, date and hour – up to 100 events;
  - Interfaces for communication with external devices - RS-485 and CAN 2.0
- 2.9. Indications of registered events**
- Light indication - LED
  - Text message - LED display -  
4 lines 20 characters per line,  
Cyrillic, backlit
  - Sound signaling - built-in sounder
- 2.10. Power supply**
- 2.10.1. Mains**
- voltage - 220/230V
  - frequency - 50/60Hz
- 2.10.2. Back up batteries**
- battery type - led, gel electrolyte
  - number of batteries - 2 pcs
  - connection - serial connection

- nominal voltage of the back up battery - 2x12V
- nominal capacity  $C_{20}$  - (7-12)Ah
- extreme discharge voltage - 21V
- charge voltage - 28,2V

### 2.10.3. Consumption on back up batteries supply

- At 24V - < 120mA

### 2.10.4. Power supply to external devices

- Voltage - (24±3)V
- Maximum current value (including current of monitored outputs ) - 2,5A

### 2.11. Dimensions

- Overall dimensions - 450x355x115mm

### 2.12. Weight

- weight (batteries not included), maximum - 6,6kg

## 3. Contents of delivery

### 3.1. Fire extinguishing control panel

- Fire detecting control panel FS5200E - 1 pc.
- Resistors 3,0kΩ/ 0,25W - 11 pcs.
- Resistors 1,5kΩ/ 0,25W - 5 pcs.
- Diode 1N4004 - 1 pc.
- Jumper for the back up batteries - 1 pc.
- Fuse 4A - 2 pcs.
- CD (Instruction manual, Operator's manual) - 1 pc.
- Packing - 1 pc.

## 4. Installation and arrangements

When fire detectors and periphery devices are integrated in the fire extinguishing control panel, avoid arranging wires in closed loops; it will reduce the control panel's resistance to electro magnetic interferences.

### 4.1. To mount the control panel

- unpack the control panel;
- put the dowels on the determined places for fixing the control panel;
- fasten the control panel to the dowels through the three holes provided on the chassis.

### 4.2. Description of inputs and outputs. Periphery devices assembly to the control panel.

All connections are to be made by means of terminals, mounted on the printed circuit board. Be advised, that the total consumption of the voltage powering the external devices (terminal "+ 28V") plus the consumption of the monitored outputs shall not exceed 2.5A in heavy duty mode.

- ◆ "L1", "L2" – Inputs for switching automatic Fire detectors. In Fire condition an extinguishing procedure starts along both lines according to set up algorithm.
- ◆ "L3" – Fire detecting line input.
- ◆ "Manual Release" – Input with line status monitoring. The input sends a signal to the control panel from a manual button to start the extinguishing procedure.
- ◆ "Mode Select" - Input with line status monitoring. The input sends a signal to the control panel from a switch for the operating mode. The modes are Manual-Automatic and Manual.
- ◆ "Hold" - Input with line status monitoring. The input sends a signal to the control panel



from a manual button or controlled contact for holding (delaying) the extinguishing procedure.

- ◆ **“On/Off Exting”** - Input with line status monitoring. The input sends a signal to the control panel from a switch for disabling the extinguishing procedure.
- ◆ **“Low Press”** - Input with line status monitoring. The input sends a signal to the control panel from pressostat contact, balance or other device to show the extinguishing agents draining.
- ◆ **“GND”** – Terminal for sending GND potential to the periphery devices.
- ◆ **“Exting”** – Active level output with line status monitoring. The output switches the extinguishing automation valves on.
- ◆ **“S2 Sounder”** – Active level output with line status monitoring. The output switches the sound-light indication on in Fire condition stage II.
- ◆ **“S1 Sounder”** – Active level output with line status monitoring. The output switches the sound-light indication on in Fire condition stage I.
- ◆ **“Rele Fire”** – Output, relay, potential free, the line status is not monitored. The output controls the devices in Fire condition of the control panel, registered by the fire detecting lines.
- ◆ **“Rel Fault”** – Output, relay, potential free, the line status is not monitored. The output controls the devices in Fault condition of the control panel.
- ◆ **“+28V”** – Three terminals for supplying 28V voltage to the periphery devices as well as the positive potential of the open collectors OK1, OK2 and OK3.
- ◆ **“OK1”** – Output open collector /in active status it supplies GND potential, in non-active status it has potential +28V via resistor 47k/0.125W/. The output controls relays, LEDs and other devices, with total consumption not exceeding 100mA. The output is active when the control panel has registered extinguishing reagent leakage.
- ◆ **“OK2”** – Output open collector /in active status it supplies GND potential, in non-active status it has potential +28V via resistor 47k/0.125W/. The output controls relays, LEDs and other devices, with total consumption not exceeding 100mA. The output is active when the control panel is in Disable Extinguishing Mode.
- ◆ **“OK3”** – Output open collector /in active status it supplies GND potential, in non-active status it has potential +28V via resistor 1k/0.125W/. The output controls relays, LEDs and other devices, with total consumption not exceeding 100mA. The output is active when the control panel is in manual Mode.
- ◆ **“Rel 2ST”** – Output, relay, potential free, the line status is not monitored. The output controls the devices in Fire condition stage II of the control panel.
- ◆ **“Rel 1ST”** – Output, relay, potential free, the line status is not monitored. The output controls the devices in Fire condition stage I of the control panel.
- ◆ **“CAN”** – Terminals to connect the two-wire line of CAN interface. The connection with the Interactive system IFS7002 /production of UniPOS LTD/ is executed via this interface. A jumper is provided that shunts the line by 120 ohms. It is needed if the fire extinguishing control panel is the final point in the interface line. The interface requires resistors 120 ohms to be mounted in both ends of the line.
- ◆ **“RS 485”** – Terminals to connect the two-wire line of RS 485 interface. The connection with a repeater, PC and other devices realized by exchange protocol - UniProtocol /FS5200E interface/ is executed via this interface. As the case with CAN interface, a jumper is provided here too with the same functions.
- ◆ **“┴”** – Terminal to connect a third wire /screen/ of the interfaces cable.

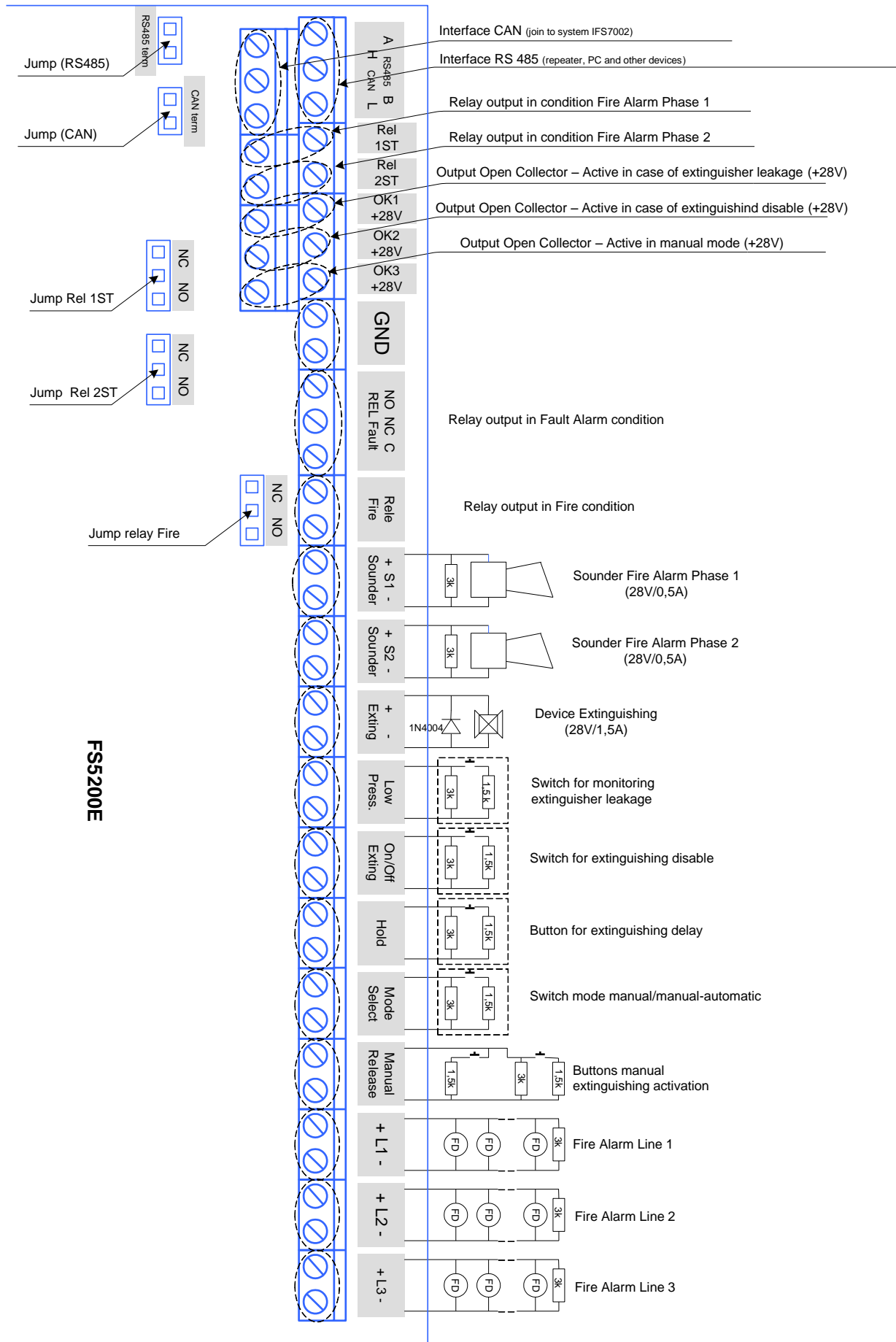

Drawing1

#### 4.2.1. Description and mounting of devices to L1, L2 and L3 inputs

Connect a two-wire line at L1, L2 and L3 inputs for connection with the Fire detectors. The line total resistance shall not exceed 100Ω. The recommended wire section depending on the lines length is:

- |             |                                |
|-------------|--------------------------------|
| ◆ To 500 m  | -cable 2 x 0.5 mm <sup>2</sup> |
| ◆ To 1000 m | -cable 2 x 1.0 mm <sup>2</sup> |
| ◆ To 1500 m | -cable 2 x 1.5 mm <sup>2</sup> |

It is recommended to make a check with a multimeter before connecting the fire detecting line to the fire extinguishing control panel. If the line is installed correctly (with mounted final resistor 3kΩ / 0.25W) between the plus and minus of the cable entering the fire extinguishing control panel the measured resistance should be 3kΩ (+/-10%). Also when measuring both wires to ground the multimeter should show no connection or leakage.

Make the connection to the terminals – “+ Lx -” (where “x” is the line number). Observe the shown polarity (Drawing 2).

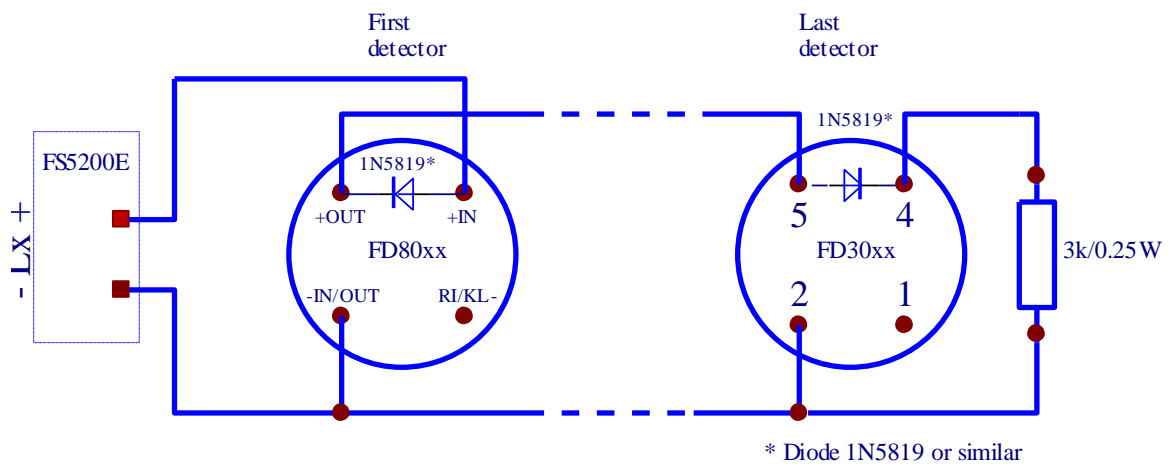

Drawing 2

Use automatic fire detectors FD3000 or FD8000 series or other compatible automatic fire detectors. Mount resistor 3 kΩ / 0.25W on the last fire detector in the line.

Mount diodes, for example 1N5819 or similar in the shown direction if you are to use the fire extinguishing control panel function to register Fault condition – removed fire detector.

Maximum 32 fire detectors could be mounted to one line regardless of their type.

When mounting the fire detectors take into consideration the specific technical characteristics of the fire detector with the fire extinguishing control panel parameters for the current threshold in the different conditions. Change the current threshold from Set up menu.

Current thresholds in a line with default parameters for the conditions:

- |            |                  |
|------------|------------------|
| ◆ 0÷3mA*   | - interruption   |
| ◆ 3÷12mA*  | - duty mode      |
| ◆ 12÷80mA* | - fire condition |
| ◆ >80mA    | - short circuit  |

Mount fire detectors on Lines 1 and 2 in the premise where the extinguishing will be performed. The first and the second line are in a logical dependence „I”; the fire extinguishing control panel enters Fire condition stage II if only both lines are activated and the extinguishing algorithm is possible to be executed.

Line 3 is only Fire detecting and it serves for fire protection of the adjoining premises to the extinguished zone. When this line is activated it switches on the outputs for Fire condition stage I as well as the common output for Fire condition. This line is not included in the extinguishing algorithm logic. Line 3 can be assumed as a standard line of a Fire control panel.

**4.2.2. Description and mounting of devices to Manual Release input**

Connect a two-wire line to the Manual Release input for connection with the manual release buttons for extinguishing activation. It is possible to mount maximum three buttons. The line is balanced and it is monitored for interruption and short circuit. Install resistors to the button terminals as shown in the connecting diagrams to monitor the condition. Install resistor 3k to the last button if 2 or 3 buttons are mounted (Drawing 3).

Connecting diagram with 1 button

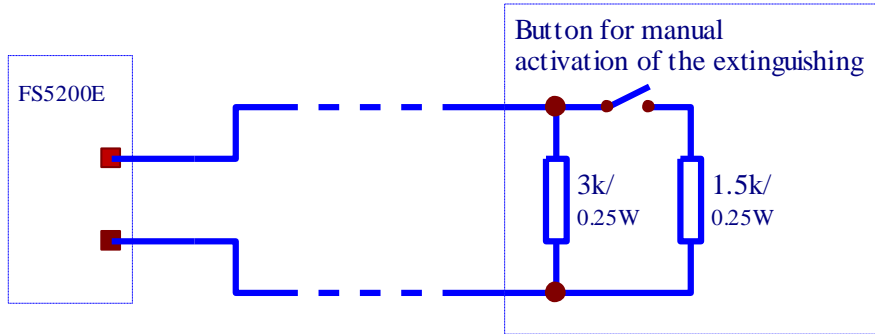

Connecting diagram with 2 buttons

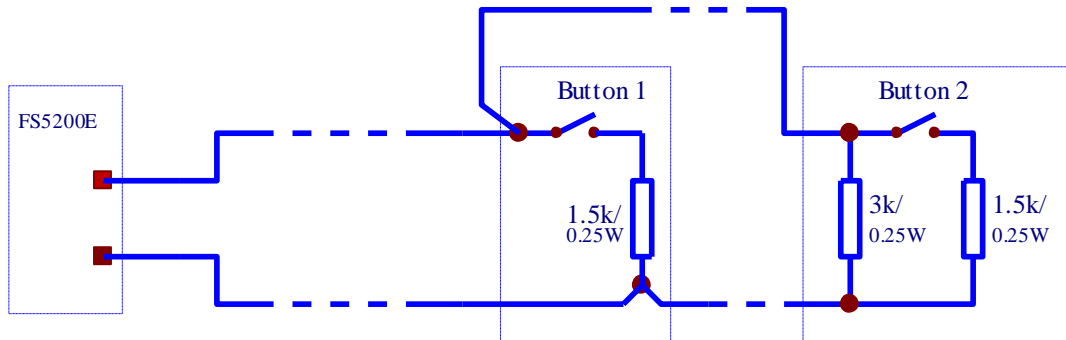

Connecting diagram with 3 buttons

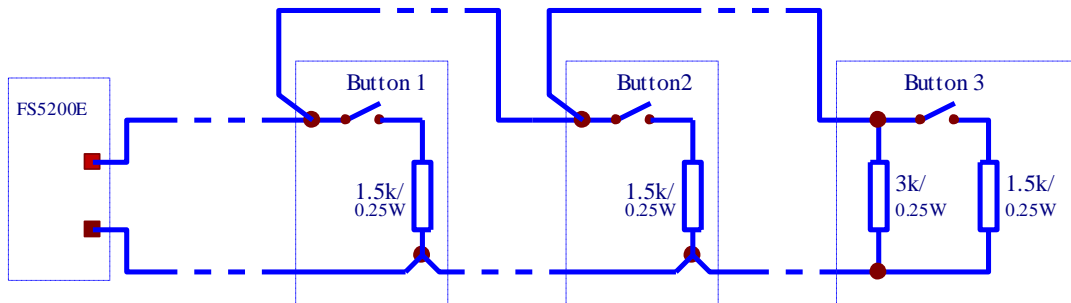

Drawing 3

When the contact is closed the fire extinguishing control panel accepts the button to be active.

**4.2.3. Description and mounting of devices to Mode Select input**

Connect a two-wire line to the Mode Select input for connection with a switch to select the fire extinguishing control panel mode – Manual-Automatic or Manual. The line is balanced and it is monitored for interruption and short circuit. Install the two resistors to the switch terminals as shown in the connecting diagram to monitor the condition.

When the contact is closed the fire extinguishing control panel accepts Manual Mode; when it is opened – Manual-Automatic Mode. Output Open collector type is activated in Manual Mode. That output could be used as switch indication, if this option is provided.

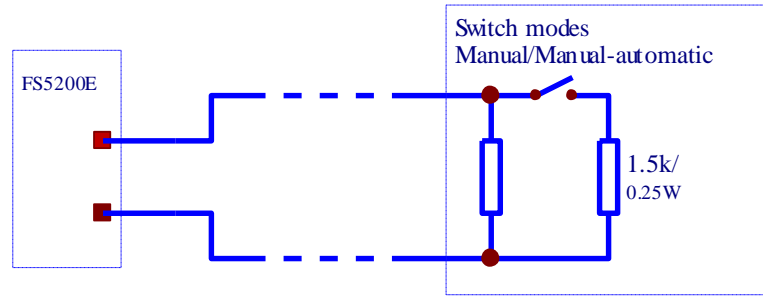

**4.2.4. Description and mounting of devices to Hold input**

Connect a two-wire line to the Hold input for connection with a switch to activate hold extinguishing function. The line is balanced and it is monitored for interruption and short circuit. Install the two resistors to the switch terminals as shown in the connecting diagram to monitor the condition (Drawing 4).

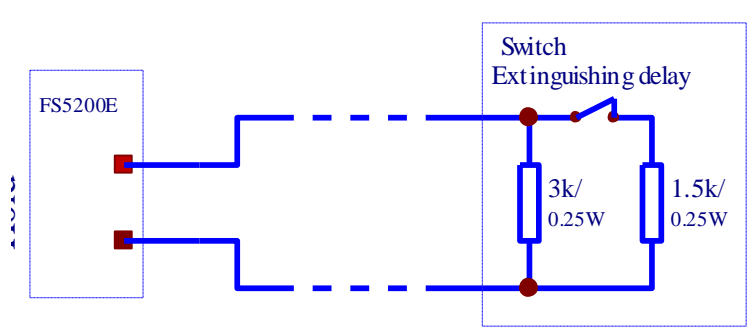

Drawing 4

Set up the input active status: **OPEN** or **CLOSED** contact from menu **System functions > Set up > Input/Outputs > Hold input**.

**Attention!** The active status of the default parameters is **OPEN** contact of the switch in order the fire extinguishing control panel to accept Hold Extinguishing function.

**4.2.5. Description and mounting of devices to On/Off Exting input**

Connect a two-wire line to the On/Off Exting input for connection with a switch to disable extinguishing. The line is balanced and it is monitored for interruption and short circuit. Install the two resistors to the switch terminals as shown in the connecting diagram to monitor the condition (Drawing 5).

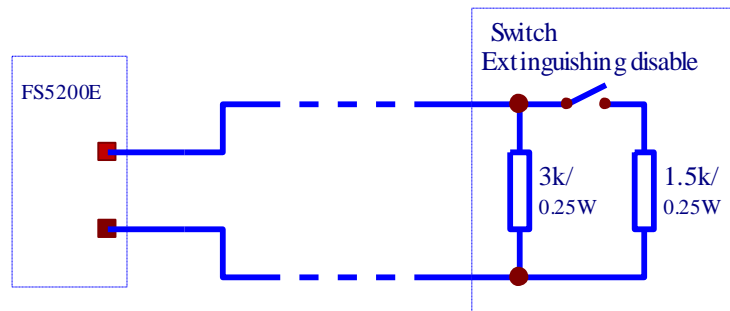

Drawing 5

When the contact is closed the fire extinguishing control panel accepts Disable Extinguishing. Output Open collector type is activated in Disable Extinguishing. That output could be used as switch indication, if this option is provided.

### 4.2.6. Description and mounting of devices to Low Press input

Connect a two-wire line to the Low Press. input for connection with a pressostat contact, balance or other devices registering a Fault condition in the extinguishing installation. The line is balanced and it is monitored for interruption and short circuit. Install the two resistors to the switch terminals as shown in the connecting diagram to monitor the condition (Drawing 6).

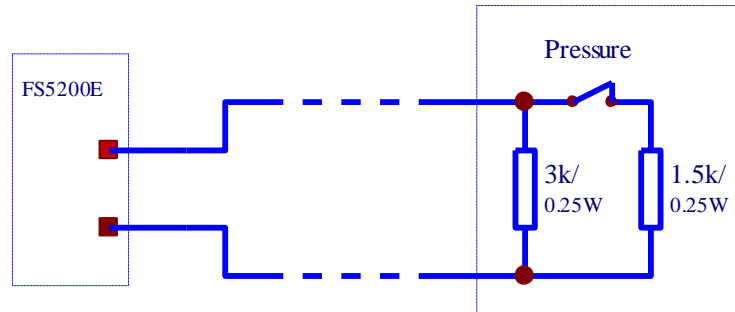

Drawing 6

Set up the input active status: **OPEN** or **CLOSED** contact from menu **System functions > Set up > Input/Outputs > Low Press input**.

**Attention!** The active status of the default parameters is **OPEN** contact of the switch in order the fire extinguishing control panel to accept the function Leaked extinguishing agent or Fault condition.

### 4.2.7. Description and mounting of devices to “Exting” output

Connect a two-wire line to the Exting output for connection with a magnetic valve or other device to activate the extinguishing automation. The line is balanced and it is monitored for interruption and short circuit. Install a diode 1N4004 or similar to the executive device terminals in the direction as shown in the connecting diagram as the valve winding resistance shall be in the range: **30Ω ÷ 3kΩ**. (Drawing 7).

Install a parallel resistor 3kΩ / 0.25W and a serial diode **1N5401** on the line if the winding resistance is less than **30Ω** (Drawing 8).

Connecting diagram if the winding valve active resistance is from 30 Ω to 3k Ω

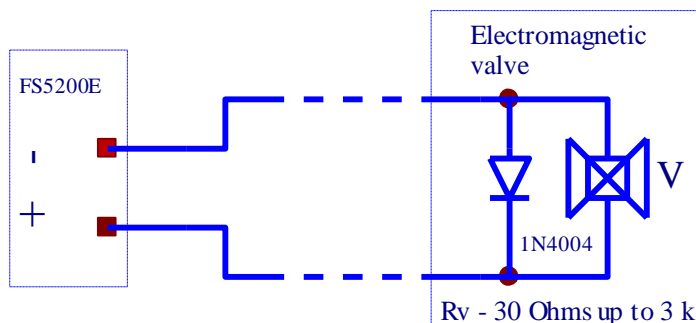

Drawing 7

Connecting diagram if the winding valve active resistance is less than 30 Ω

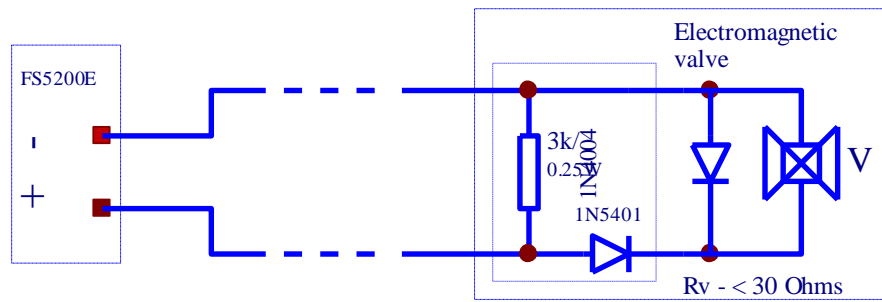

Drawing 8

Upon the output activation the supplied voltage ( $24\pm 3$ )V is with load-carrying capacity of 1.5A.

The time for output activation could be set from 2 to 255 seconds from menu **System functions > Set up > Extinguishing time** and it depends on the type of the used executive device. The default setting is 10 seconds.

**4.2.8. Description and mounting of devices to Sounder S1 and Sounder S2 outputs**

Connect a two-wire line to the Sounder output for connection with sound and light signaling devices. The line is balanced and it is monitored for interruption and short circuit. Install a resistor  $3k\Omega/0.25W$  to the signaling device terminals to monitor the condition (Drawing 9).

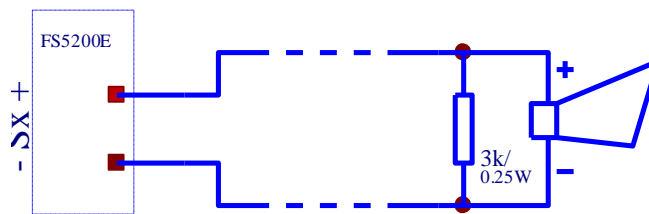

Drawing 9

Upon the outputs activation the supplied voltage ( $24\pm 3$ )V is with load-carrying capacity of 0.5A.

The outputs are activated for Fire condition stage I and Fire condition stage II, respectively.

The fire extinguishing control panel provides the option for Sounder S1 output disable from menu **System functions > Disables > Disable S1 output** .

**4.2.9. Description and mounting of devices to outputs OK1, OK2 and OK3 open collector type**

OKx outputs send a signal to relays, LEDs and other devices to follow and monitor the fire extinguishing control panel condition. The outputs are not monitored for the line status.

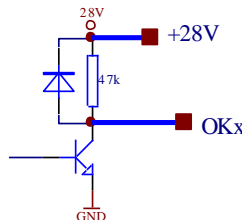

Drawing 10

Upon activation of the outputs GND potential is supplied with load-carrying capacity of 0.1A.

The internal diagram of output Open collector type is presented on the drawing (Drawing 10).

**4.2.10. Description and mounting of devices to Rel Fire output**

Rel Fire is a potential free, relay output. The logic of the contact - Normally Open or Normally Closed could be adjusted by means of a jumper. The output is not monitored. The output is activated in Fire condition along one or both fire detecting lines.

#### 4.2.11. Description and mounting of devices to Rel 1<sup>ST</sup> and Rel 2<sup>ND</sup> outputs

Rel 1<sup>ST</sup> and Rel 2<sup>ND</sup> are potential free, relay outputs. The logic of the contact - Normally Open or Normally Closed could be adjusted by means of a jumper. The outputs are not monitored. The outputs are activated in Fire condition stage I and Fire condition stage II, respectively. The fire extinguishing control panel provides the option to disable the activation of Rel 1<sup>ST</sup> and Rel 2<sup>ND</sup> outputs from menu **System functions > Disables > Disable Rel 1ST / Disable Rel 2ND**.

#### 4.2.12. Description and mounting of devices to Rel Fault output

Rel Fault is a potential free, relay output, as both relay contacts are possible Normally Open or Normally Closed. The output is not monitored.

#### 4.2.13. Description and mounting of devices to RS485 interface terminals

RS485 interface is designed to transmit information and to receive commands from FS5200R repeater. The following connection configurations are possible:

- One fire extinguishing control panel and one repeater
- One fire extinguishing control panel and up to 6 repeaters
- Up to 15 fire extinguishing control panels and 1 repeater
- Up to 6 repeaters and up to 10 fire extinguishing control panels (If less than 6 repeaters are installed they could be substituted by fire extinguishing control panels, i.e. configuration of 3 repeaters and 13 fire extinguishing control panels, etc.)

FS5200R repeater receives information from all fire extinguishing control panels as it indicates the occurred events by sound signaling, light indication and text messages. It is also possible a remote fire extinguishing control panel to be reset.

RS485 interface could be used also for communication with other intelligent devices and PCs.

The connection between the devices along RS485 is parallel connection. Observe the requirement potential A and B not to be crossed. The maximum distance between the end devices is 1000 meters. Jumper to shunt the line by 120 ohms has to be installed on the first and the last device regardless the line length. On all other devices the jumper has to be removed (Drawing 11).

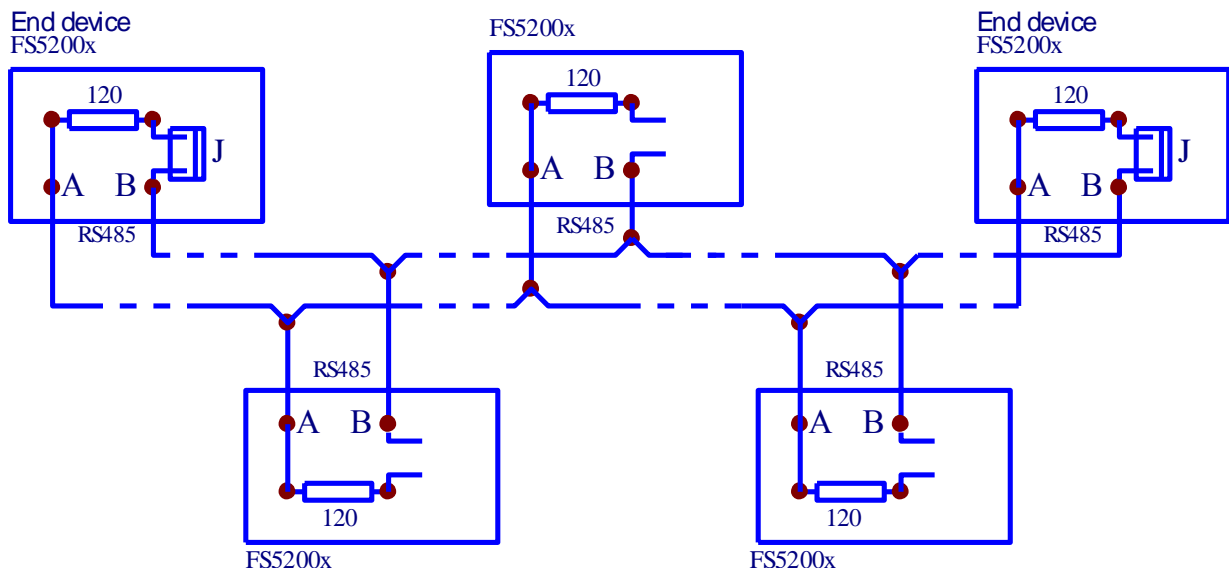

Drawing 11

#### 4.3. Power supply connection

Connect a feeding cable to the terminal with mains fuse, observing the following positions (Appendix 3):

- P – power wire “Phase”;



- N – power wire “Null”;
- Ground - safety ground wire.

The cable shall be double insulated and of 0,5mm<sup>2</sup> section for the power supply wires, and of 1,5mm<sup>2</sup> section for the safety ground wire.

The other end of the feeding cable is connected to the mains power supply by means of junction box.

The mains power supply of the fire control panel shall be in a separate loop.

## 5. General information

### 5.1. Access levels

4 levels of access to the variable indications and control functions of FS5200E are available.

#### 5.1.1. Access level 1

All persons who would presumably find out and react to alarm upon fire condition or fault condition have access to level 1.

The following actions are accessible:

- Displaying suppressed messages for Fire condition stage I, Fire Condition stage II, Fault condition, Disabled components;
- Forced proceeding from phase Fire condition stage I to phase Fire condition stage II ;
- Suppressing the local sounder;
- Displaying the status of the lines and the monitored outputs (see section 12.5);

All light indicators are visible.

#### 5.1.2. Access level 2

The personnel in charge of the fire protection have access to level 2; they shall be trained and authorized to operate the fire control panel in the following conditions:

- Duty Mode;
- Fire condition stage I;
- Fire condition stage II;
- Fault condition;
- Disabled component;
- Information and adjustment.

To enter Access level 2, turn the key on the front panel of the fire extinguishing control panel into

position .

The following features of the fire extinguishing control panel are accessible:

- All features accessible at Level 1;
- Switching off the outputs, activated upon fire condition;
- Exit of Fire condition;
- System functions of the fire extinguishing control panel except entering Set up Mode (see section **Error! Reference source not found.**).

#### 5.1.3. Access level 3

Accessible for personnel trained and authorized for:

- Reconfiguration of specific data – of the protected site or of the fire extinguishing control panel – saved in the memory;
- Maintenance of the fire control panel.

This level has two sublevels of access - 3A and 3B.

Level 3, sublevel 3A, is accessed through a **password entered at Access level 2**. At this sublevel the functions for reconfiguration of specific data for the protected site or the fire extinguishing control panel are accessible.

Level 3, sublevel 3B is accessed when the fire extinguishing control panel is opened. The following features are accessible:

- Replacing a burnt fuse;
- Adding, removing or replacing a module;
- Connecting fire detecting lines and executive devices.

#### 5.1.4. Access Level 4

















Accessible for personnel trained and authorized by the Producer to repair the fire extinguishing control panel and to modify the software.

Special means are required to enter this level.

#### 5.2. Indications and buttons for control



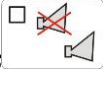





Table 1 gives detail description of the indications for each status, Table 2 presents the basic function of the control buttons. Appendix 1 shows the front panel of FS5200 with the indications and buttons for control.

**Table 1**

Conditions of the fire extinguishing control panel	Indication
All conditions - The fire extinguishing control panel is power supplied	 Indicator <i>Power Supply</i> – continuous green light
Fire condition – Fire condition Stage I and Stage II	 Individual indicators for Fire condition in the fire detecting lines
Fire condition – Fire condition Stage I	 Common indicator <i>Fire condition Stage I</i> – continuous red light
Fire condition – Fire condition Stage II	 Common indicator <i>Fire condition Stage II</i> – flashing red light during the evacuation time and continuous red light after the automated extinguishing is switched on
Manual Mode – a signal for manual mode of extinguishing control is given	 Indicator <i>Manual Mode</i> - continuous yellow light
Manual Mode – a signal for manual mode of extinguishing control is given	 Indicator <i>Manual-Automatic Mode</i> - continuous yellow light
Disabled extinguishing – a signal disabling the extinguishing is given	 Indicator <i>Disabled Extinguishing</i> - continuous yellow light
Extinguishing held – a signal holding the extinguishing is given	 Indicator <i>Extinguishing Held</i> - continuous yellow light
Fire Condition and Fault Condition – the sound indication is suppressed	 Indicator <i>Stop Alarm</i> - continuous red light
Fire condition Stage I - The fire condition stage I outputs are suppressed	 Indicator <i>Suppressed Outputs</i> - continuous red light
Fault condition - All faults except for <i>Battery Low</i>	 Common indicator <i>Fault Condition</i> - continuous yellow light
Fault condition – System Error and new Configuration	 Indicator <i>System Error</i> - continuous yellow light
Fault condition – Fault in mains supply or backup battery	 Indicator <i>mains Supply Fault</i> - continuous yellow light
Fault condition – fault condition in monitored line	 Indicator <i>Monitored Line Fault</i> - continuous yellow light
Fault condition – fault condition Low pressure in the extinguishing installation	 Indicator <i>Low Pressure Fault</i> - continuous yellow light
Disabled component - Disabled line or monitored output	 Indicator <i>Disabled Component</i> – continuous yellow light
Fire condition Stage I	Local sounder – discontinuous signal: 4 sound impulses for 1 s, followed by 1 s break
Fire condition Stage II	Local sounder – continuous signal

<b>Conditions of the fire extinguishing control panel</b>	<b>Indication</b>
Fault condition - All faults except for <i>Battery Low</i>	Local sounder – discontinuous signal: 1 s sound, followed by 1 s break
Fault condition - Low battery	Local sounder – discontinuous signal: 1 s sound, followed by 3 s break

Table 2

Means of control	Condition of the fire extinguishing control panel	Access level	operation
Access level 2 key		Level 1	Status 
		Level 2	Status 
Button <i>Line Reset</i> 	Fire condition	Level 2	Output from Fire Condition stage I or Fire condition stage II initiated on the display
Button <i>Outputs</i> 	Fire condition, phase Fire condition Stage I	Level 2	- if outcomes for Fire condition Stage I are activated – to suppress them; - if outcomes for Fire condition Stage I are suppressed – to activate them
	Fire condition, phase Fire condition Stage II	Level 2	- If the common output for fire condition is activated – to suppress it; - if there is no activated common output for fire condition – to activate it
Button <i>Alarm</i> 	Fire condition Stage I or Stage II and Fault condition*	Level 1	To suppress/activate the local sounder
Button <i>Menu</i> 	Duty Mode, Fire condition, Fault condition*, Test and Disabled component	Levels 1 and 2	To enter Information and Control Mode
	Information and Control Mode	Levels 1 and 2	- To enter the selected menu; - To execute the selected command;
	Set up Mode	Level 3A	- To save the modified parameter
Button <i>Down</i> 	Fire condition Levels 1 and 2 To show on the display the next message for fire condition		
	Information and Control Mode	Levels 1 and 2	- To show on the display the next element from the menu;
	Set up Mode	Level 3A	- To move the cursor; - To modify the selected parameter
Button <i>Up</i> 	Fire Condition	Levels 1 and 2	To show on the display the previous message for fire condition
	Information and Control Mode	Levels 1 and 2	- To show on the display the previous element from the menu;
	Set up Mode	Level 3A	- To modify the selected parameter
Button <i>Cancel</i> 	Information and Control Mode	Levels 1 and 2	- To exit a function without saving changes in the parameter; the command will not be executed;
	Set up Mode	Level 3A	- To exit the current menu and to move to an upper hierarchy menu

\* Not operating in Fault condition (fatal fault condition except New Configuration).

### 5.3. Conditions of the Fire Extinguishing Control Panel

The fire extinguishing control panel FS5200E monitors the fire detecting lines and the monitored outputs as it scans consecutively their status. Depending on the current the fire extinguishing control panel could be in Duty Mode, in Fire condition or Fault condition (short circuit or interruption). Depending on the measured parameters the inputs could be in Fault condition (short circuit or

interruption) or active status. Simultaneously the monitored outputs are followed constantly for in Fault condition (short circuit or interruption).

The fire extinguishing control panel FS5200E operates in eight main conditions: Duty Mode, Fire condition Stage I, Fire condition Stage II, Fault Condition, Disabled component, Test Mode, Information and Control Mode and Set up Mode.

At any time the fire extinguishing control panel could be in each one of these conditions or in random combination of the conditions: Fire condition Stage I, Fire condition Stage II, Fault Condition, Disabled component, Test Mode, Information and Control Mode.

Duty Mode, Set up Mode and Remote Control cannot be combined with another condition:

- the fire extinguishing control panel enters Duty Mode when it is not in any of the other conditions;
- to enter Set up Mode and Remote Control the fire extinguishing control panel has to exit the other conditions.



## 6. Duty Mode

### 6.1. Description

The fire extinguishing control panel is in Duty Mode, when it is not in any other of the rest eight possible conditions.

### 6.2. Indication

#### 6.2.1. LED and sound indication

In Duty Mode only the green LED indicator is activated  (Power supply) and the yellow indicator  (Manual Mode – activated if only the fire extinguishing control panel is in Manual Mode. The local sounder is off.

#### 6.2.2. Text message

The display is divided into panels. The last line shows the condition of both Fire detecting lines that shall be in Protection status. The display also shows the message *Protection* and the current astronomic time:

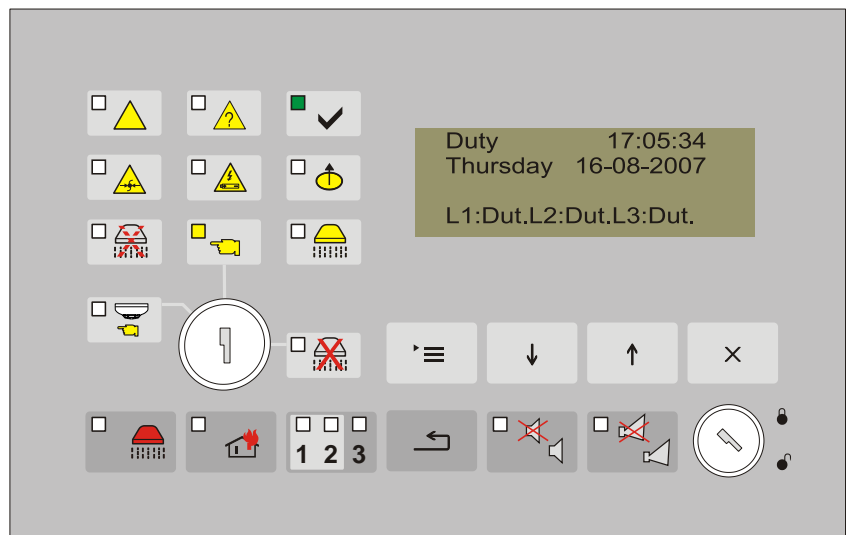

### 6.3. Using the keypad

The only accessible button in Duty Mode is  (Menu). Press it and the fire control panel enters Information and Control Mode (p.12).

## 7. Fire Condition Stage I

### 7.1. Description

The fire extinguishing control panel enters Fire condition phase Fire condition Stage I, when

- An automatic fire detector is activated only along one of the Fire detecting lines;

- An automatic fire detector is activated along the first or the second or the third line

To exit this condition press button  at Access level 2

**7.2. Indication**

**7.2.1. LED and sound indication**

In this condition:



- The indicator  (Power Supply) illuminates in green light;

- The indicator  (Fire condition Stage I) illuminates in red light;

- The indicator of the respective line in Fire condition  illuminates in red light;

- If the outputs for phase Fire condition Stage I are suppressed by button  (Outputs), the LED indicator of the button illuminates in continuous red light.

- If the sound indication is suppressed by button  (Alarm) the LED indicator of the button illuminates in continuous red light.

- The indicator  (Manual Mode) or the indicator  (Manual-Automatic Mode) illuminates in yellow light depending on the selected mode of operation.

The local sounder produces discontinuous signal.

**7.2.2. Text message**

In this condition the display is divided into two text fields. The top one shows the condition of the control panel, the bottom one – the condition of the lines.



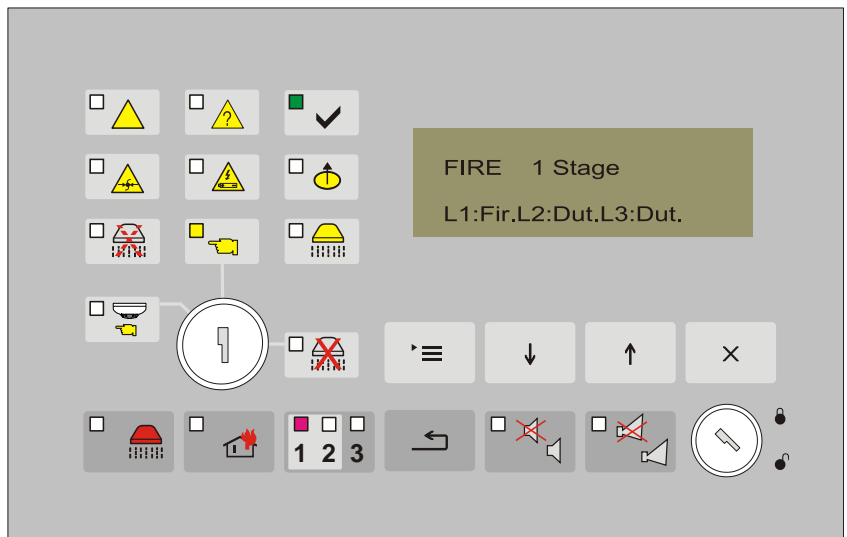



**Example:** Fire condition is registered along the first line. The indicator of line 1 and the indicator for Fire condition Stage I illuminate in red light. The text message shows the Fire condition stage and the line in which the fire extinguishing control panel is in Fire condition.



Potential free relays Rele 1St and Rele Fire are activated. Voltage 28V DC is supplied to the sounder output S1.

**7.3. Using the keypad**

Button	Access level	Operation	Additional information
 Button (Alarm)	all	Press it to: <ul style="list-style-type: none"> <li>- suppress the local sounder;</li> <li>- activate the local sounder if the fire extinguishing control panel is in Fire condition Stage I or Fault condition and the local sounder has been suppressed by previous pressing of the same button.</li> </ul>	The button operation is reversible i.e. press it once to change the current condition alternatively – suppressed or activated local sounder. The LED indicator illuminates if the active condition of the local sounder is suppressed. The local sounder is activated again: <ul style="list-style-type: none"> <li>- when the fire</li> </ul>

			extinguishing control panel enters Fire condition Stage II; - upon Fault condition.
Button (Outputs) 	2, 3 and 4	Press the button to: - suppress the outputs activated for phase Fire condition Stage I - to activate the suppressed outputs, if any	Access level 2 is required to for operation with this button. The key on the front panel should be in position  . The button operation is reversive i.e. press it once to change the current condition alternatively – suppressed or activated outputs. The LED indicator illuminates if the active condition is suppressed outputs.
Button (Line Reset) 	2, 3 and 4	Press it to force the fire extinguishing control panel to exit Fire condition Stage I and to reset the line that was in Fire condition (the power supply is switched off for 3s).	Access level 2 is required to for operation with this button. The key on the front panel should be in position  .
Button (Menu) 	all	Press it to enter Information and Control Mode.	
Button (Cancel) 	all	Press it to exit Information and Control Mode. The main screen for the current status Fire condition Stage I is visualized.	

## 8. Fire Condition Stage II

### 8.1. Description

The fire extinguishing control panel enters Fire condition phase Fire condition Stage II, in the case of:

- fire condition along both fire detecting lines;
- manual button activation for forced extinguishing.

In this phase the active extinguishing procedure is initiated.

In phase Fire Condition Stage II the following steps are formed connected with the algorithm of the extinguishing procedure:

- Evacuation time;
- Activation of the devices to Release the extinguishing mixture



### 8.2. Indication

#### 8.2.1. LED and sound indication

In Fire Condition Stage II and the fire extinguishing control panel in the evacuation step the LED indicator illuminates in red flashing light  (Fire Stage II).



In Fire Condition Stage II and expired evacuation time the fire extinguishing control panel activates the extinguishing devices and the LED indicator  (Fire Stage II) illuminates in red continuous light.

The indicator  (Manual Mode) or the indicator  (Manual-Automatic Mode) illuminates in yellow light depending on the selected mode of operation.

The local sounder produces continuous signal. If the sound signaling is suppressed by button  (Alarm), the LED indicator of the button illuminates in continuous red light.

**8.2.2. Text messages during the evacuation step and fire along both lines.**

The display shows:

The message EVACUATION and the remaining time for the activation of the extinguishing devices message FIRE STAGE 2 and information for the current status of the lines:

**Example:** Fire condition along line 1 and line 2. The fire extinguishing control panel is in evacuation phase. The indicator for Fire condition Stage II illuminates in flashing red light. The individual indicators for line 1 and line 2 are illuminated too.

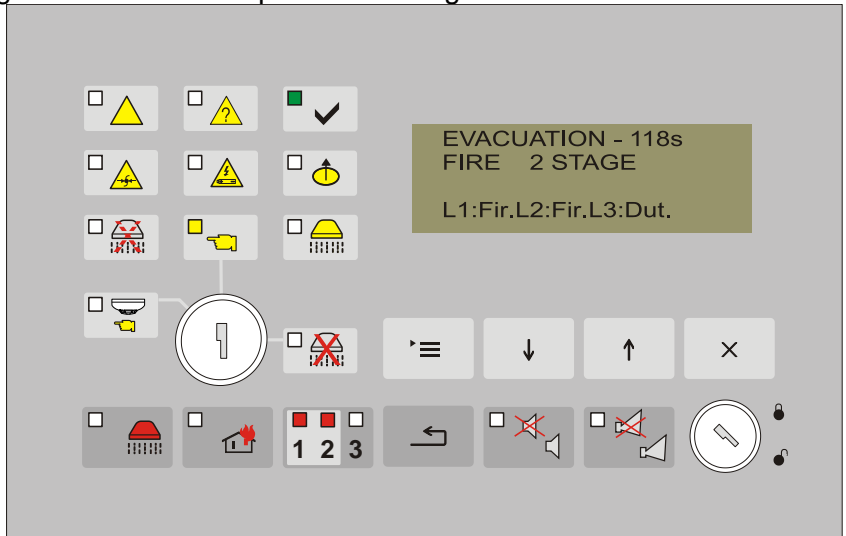

Text message for the phase of fire alarm, the remaining time for activation of the extinguishing devices and the current status of the lines is visualized on the display. The local sounder produces continuous signal. Potential free relays Rele 2St and Rele Fire are activated. Voltage 28V DC is supplied to the sounder output S2.

**8.2.3. Text messages during the evacuation step and manual button activation.**

The display shows:

The message EVACUATION and the remaining time for the activation of the extinguishing devices message FIRE STAGE 2 Message showing manual activation and information for the current status of the lines

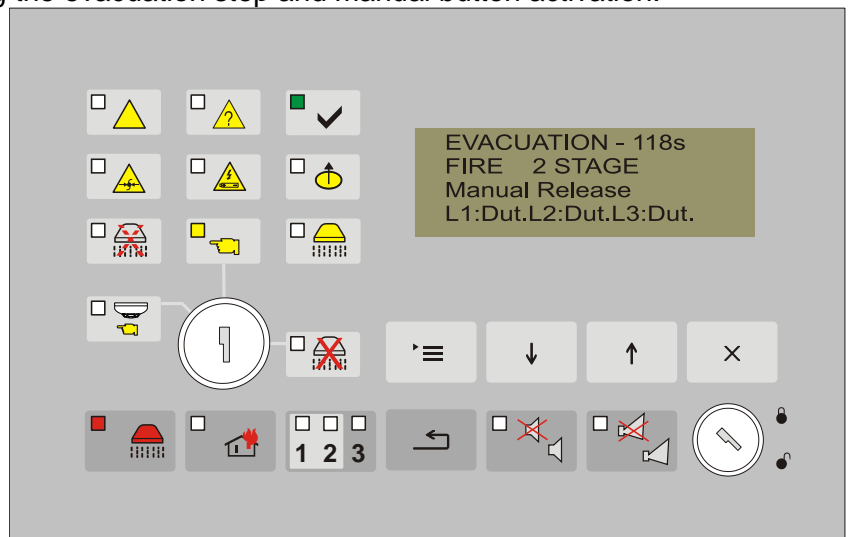

**8.2.4. Text messages when the extinguishing device is activated.**



The display shows:

The message ATTENTION GAS! and EXTINGUISHING ON indicating that the extinguishing agent is released.

Information for the current status of the lines:

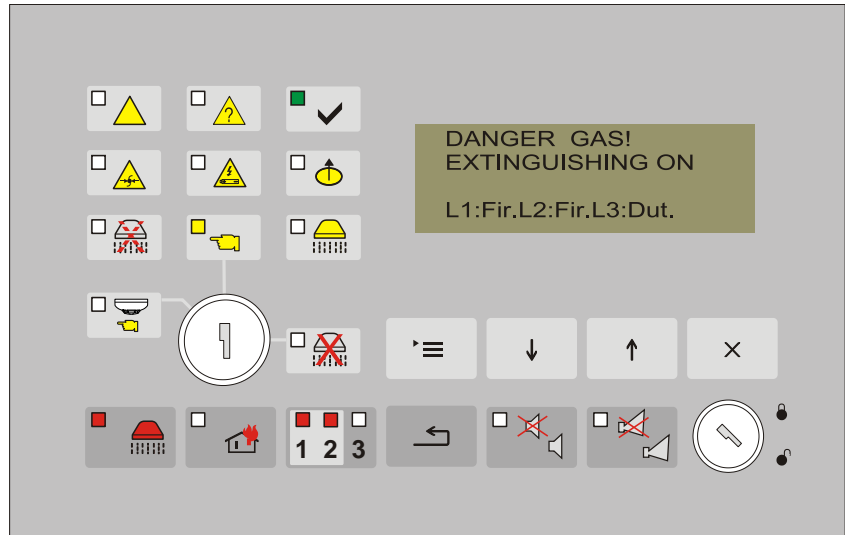

This indication could be suppressed by the screens in Fire condition. The suppressed messages could be displayed in Information and Control Mode.





**Example:** Fire condition along line 1 and line 2. The fire extinguishing control panel is in phase to start extinguishing procedure. The indicator for Fire condition Stage II illuminates in continuous red light. The individual indicators for line 1 and line 2 are illuminated too. The display shows warning messages and the condition of the fire detecting lines. The local sounder produces continuous signal. Potential free relays Rele 2St and Rele Fire are activated. Voltage 28V DC is supplied to the outputs S2 and Exting. .

**Note:** The entry of the fire extinguishing control panel in Fire condition along a new line (e.g. the 3<sup>rd</sup> one) is indicated by the standard sound and light indication and text messages.

**8.3. Using the keypad**

Button	Access level	Operation	Additional information
Button (Alarm) 	all	Press it to: <ul style="list-style-type: none"> <li>- suppress the local sounder;</li> <li>- activate the local sounder if the fire extinguishing control panel is in Fire condition Stage II or Fault condition and the local sounder has been suppressed by previous pressing of the same button.</li> </ul>	The button operation is reversionary i.e. press it once to change the current condition alternatively – suppressed or activated local sounder. The LED indicator illuminates if the active condition of the local sounder is suppressed. The local sounder is activated again: <ul style="list-style-type: none"> <li>- when the fire extinguishing control panel enters Fire condition long a new line;</li> <li>- upon Fault condition.</li> </ul>
Button (Outputs) 	2, 3 and 4	Press the button to suppress/activate the fire relay <i>Rele Fire</i>	Access level 2 is required for operation with this button. The key on the front panel should be in position  . The button operation is reversionary i.e. press it once to change the current condition alternatively – suppressed or activated outputs. The LED indicator illuminates if the active condition is suppressed outputs.

Button (Line Reset) 	2, 3 and 4	Press it to force the fire extinguishing control panel to exit Fire condition Stage II and to reset the lines that were in Fire condition (the power supply is switched off for 3s).	Access level 2 is required to for operation with this button. The key on the front panel should be in position  .
--	------------	--	--

#### 8.4. Using the switch for mode selection (Automatic/Manual/Disabled)

Use the switch for mode selection to prolong or cancel the evacuation if it turns out that it is not necessary the extinguishing devices to be activated.

Turn the switch to the right, in position  to disable the activation of the extinguishing devices.

In addition the indicators for disabled extinguishing start to illuminate in yellow light. The display shows a text message for the entered disable and the fire condition stage.

Turn the switch to position *Manual* to enable the extinguishing and the evacuation time to be counted down again.

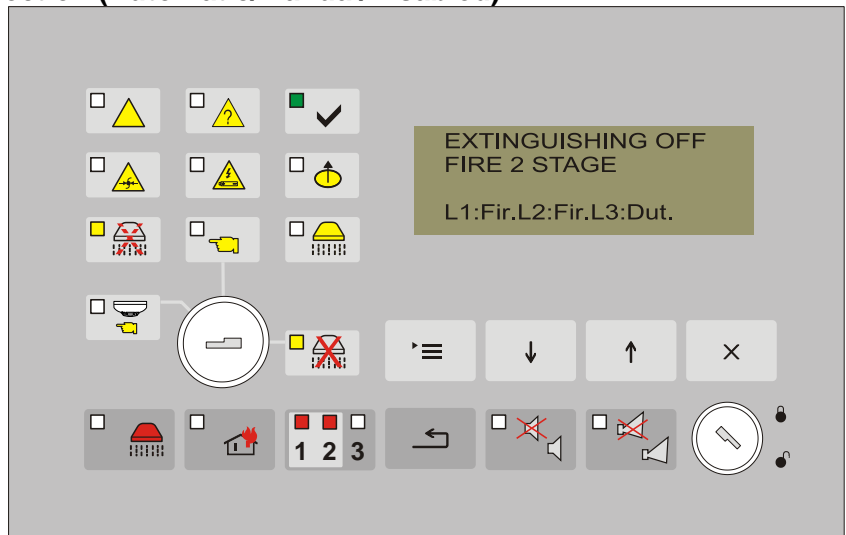

### 9. Fault condition

#### 9.1. Description

The fire extinguishing control panel enters Fault Condition when any of the events below have been registered:

- Battery low – backup batteries discharged due to interruption of mains supply;
- Fault in a processor programme;
- Fault in the real time clock;
- Fault in the line – removed fire detector, short circuit or interruption;
- Fault in a monitored output – short circuit or interruption;
- Fault in a monitored input – short circuit or interruption;
- Signal for lack of extinguishing agent;
- Fault in the mains supply;
- Fault in backup battery supply;
- Short circuit to ground wire;
- Fault in the positive supply of the lines;
- Fault in the negative supply of the lines;
- Fault in the power supply of external devices.

Upon fault condition *Short circuit to ground wire* the following faults occur:

- Fault condition in a line (removed fire detector) – when the short circuit is to a fire detecting line element;
- Fault condition in a monitored output (interruption) – when the short circuit is to a monitored output element.





Fault condition is indicated by text messages on the display. The LEDs indicators provide additional information.

**9.2. Indication**

**9.2.1. LED and sound indication**

Upon *Fault battery low* LED indicator is not activated. The local sounder produces a discontinuous signal (sound for 1s, followed by 3s break). The LCD display illumination is off.

All other fault conditions are designated by indicator  (Fault condition), illuminating in continuous yellow light. Depending on the specific fault, the following indicators are illuminated too:

- Upon *System error* - indicator  (System error) in flashing yellow line;
- Upon *Fault in a monitored line* - indicator  (Fault – short circuit or monitored line interruption) in continuous yellow light;
- Upon *Fault in mains supply* or *Backup battery supply* - indicator  (Fault in mains supply) in continuous yellow light;
- Upon *Fault in the extinguishing device* or *Extinguishing agent release* - indicator  (Fault low pressure) in continuous yellow light;

The local sounder produces a discontinuous signal. If the sound indication is suppressed by button

 (Alarm), the LED indicator of the button illuminates in continuous red light.

**9.2.2. Text messages**

The fault conditions messages are displayed by priority as given in section 9.1.

The fatal system errors screens suppress all other messages. If more than one non-fatal faults are registered, they are indicated by priority as the message with the highest priority suppresses the rest of the fault messages.

Upon registration of a Fault condition, the relay REL Fault is activated, as it closes contact NO and opens contact NC.

When the fire extinguishing control panel enters Fire condition the messages for Fault conditions are suppressed. To view the suppressed messages enter Information and Control Mode.

Upon registration of a Fault condition the fire extinguishing control panel displays the respective light indication and text messages:

- the common indicator  for fault condition is illuminated
- the specialized indicator showing the type of the fault condition is illuminated;
- the total number of faults and the type of the specific fault are visualized on the display;

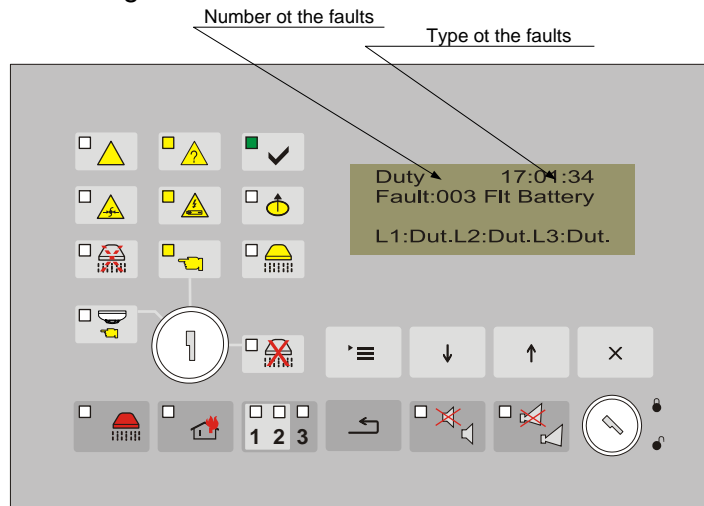

Upon non-fatal faults when the fire extinguishing control panel is not in Fire condition, the following information screens appear:

- \* Faults in monitored outputs:  
(The field “EEE” shows the number of the faults;  
The field “Status” shows the monitored output status, i.e. the type of the fault)
- \* Fault in the mains supply:  
(The field “EEE” shows the number of the faults).  
In this case the display illumination is off. To turn it on press the button. 20s after the last pressing of the button it is off again.
- \* Fault in backup battery supply:  
(The field “EEE” shows the number of the faults).
- \* Fault in the power supply of external devices – activated fuse:  
(The field “EEE” shows the number of the faults).
- \* Short circuit to grounded wire:  
(The field “EEE” shows the number of the faults).
- \* Fault in the negative supply:  
(The field “EEE” shows the number of the faults).

```
Duty          17:05:34
Fault:EEE MONN Status
L1:Dut.L2:Dut.L3:Dut
```

```
Duty          17:05:34
Fault:EEE Flt Mn Power
L1:Dut.L2:Dut.L3:Dut
```

```
Duty          17:05:34
Fault:EEE Flt Battery
L1:Dut.L2:Dut.L3:Dut
```

```
Duty          17:05:34
Fault:EEE FltPower 28V
L1:Dut.L2:Dut.L3:Dut
```

```
Duty          17:05:34
Fault:EEE Fault Earth
L1:Dut.L2:Dut.L3:Dut
```

```
Duty          17:05:34
Fault:EEE FltPower -5V
L1:Dut.L2:Dut.L3:Dut
```

When the fire extinguishing control panel is in Fire condition, the fault messages are suppressed. The suppressed messages could be seen in Information and Control Mode.

Upon fault in the Fire detecting line, the type of fault could be seen in the individual field of the respective line, as the abbreviations mean:

- „Sho” – Fault - Short circuit;
- „Int” – Fault – interruption;
- „ReD” – Fault – Removed fire detector.

### 9.3. Using the keypad

None of the buttons is active upon fatal fault condition (except for New Configuration).

For all other fault condition 2 buttons are being supported. Where the fire extinguishing control panel operates in combination of other conditions, their buttons are active too.

Button	Access level	Operation	Additional information
 Button (Alarm)	all	Press it to: <ul style="list-style-type: none"> <li>- suppress the local sounder;</li> <li>- activate the local sounder if the fire extinguishing control panel is in Fire condition or Fault condition and the local sounder has been suppressed by previous</li> </ul>	The button operation is reversive i.e. press it once to change the current condition alternatively – suppressed or activated local sounder. The LED indicator illuminates if the active condition of the local sounder is suppressed.

		pressing of the same button.	The local sounder is activated again: - when the fire extinguishing control panel enters Fire condition; - new Fault condition occurs;
Button (Menu)		all Press it to enter Information and Control Mode. All occurred faults could be viewed in Menu View <i>Faults</i> .	For detailed information how to view all faults in Information and Control Mode see section 12.

**10. Disabled component**

**10.1. Description**

The fire extinguishing control panel enters *Disabled component* after a manual operation, disabling a fire alarm line or an output.

At access level 2 – Secret switch in position  and menu **System Functions> Disables** it is possible the following inputs and outputs to be disabled:

- > **Disable Line 1 ;**
- > **Disable Line 2 ;**
- > **Disable Line 3 ;**
- > **Disable Rel 1ST ;**
- > **Disable Rel 2ST ;**
- > **Disable Out. S1 .**

Upon fire detecting line disable the power supply to the line is switched off and nor processing is done.

Upon output disable, the respective output is not activated under any circumstances.

**10.2. Indication**

**10.2.1. LED and sound indication**

If a component is disabled the indicator  starts to illuminate. No sound indication is supported for this condition.

**10.2.2. Text messages**

When a fire detecting line is disabled it is indicated on the display in the status of the line.

There is no text message for disabled output.

All entered disables could be viewed in Information and Control mode.

**Example:** *Disable for line 1 is entered. The indicator  is illuminated, in the line status there is a text message “Dis”.*

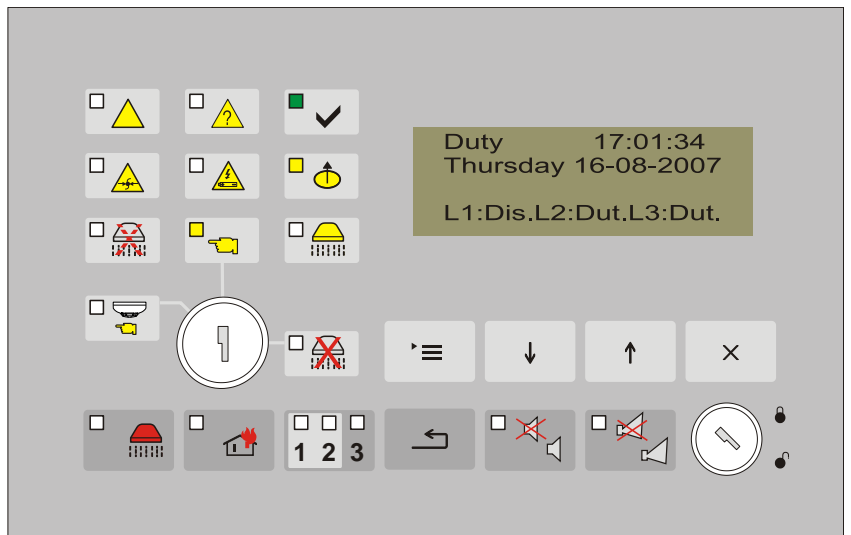

**10.3. Using the keypad**

Button	Access level	Operation	Additional information
Button (Menu) 	all	Press it to enter Information and Control Mode. All entered disables could be viewed in Menu <i>View Disables</i> .	For detailed information how to view all entered disables in Information and Control Mode see section 12.

**11. Test Mode**

**11.1. Description**

The fire extinguishing control panel enters Test Mode through manual operation setting a fire alarm line to Test Mode. The condition is handled via Information and Control Menus.

Where a fire alarm line is set to Test Mode, the following changes take effect:

- Where *Fire condition stage I* or *Fire condition stage II* is detected in the line, sound and LEDs indications are not triggered; i.e. the fire extinguishing control panel does not enter Fire Condition;
- in Test Mode the line is reset, the power supply is interrupted every 64 seconds for a period of 3 seconds;
- from the possible faults along the line only the fault condition *Short Circuit* is processed.

**11.2. Indication**

**11.2.1. LED and sound indication**

This condition does not have specific LED and sound indication.

**11.2.2. Text messages**

Where a fire alarm line is set to Test Mode, a text message showing the status of the line appears on the display.

All lines in Test Mode could be viewed in Information and Control Mode.

**Example:** *Line 1 is set to Test Mode. In the status of the line there is a text message "Tes".*

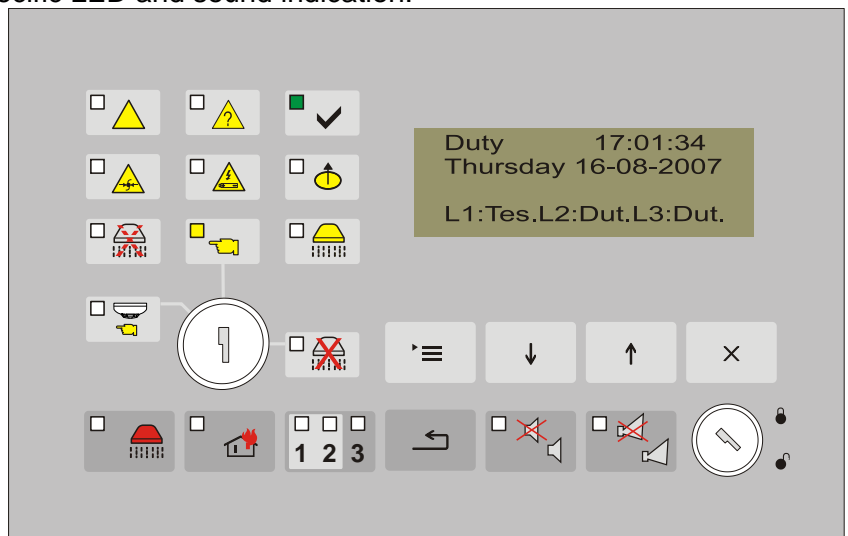

**11.3. Using the keypad**

Button	Access level	Operation	Additional information
Button (Menu) 	all	Press it to enter Information and Control Mode. All lines set to Test Mode could be viewed in Menu <i>View Test</i> .	For detailed information how to view all lines set to Test Mode in Information and Control Mode see section 12.

## 12. Information and Control Mode

### 12.1. Description

Information and Control Mode provides the user with the possibilities to display information associated with the settings of the fire extinguishing control panel, and to enter control data.

The operation in this mode could be in combination with the following modes of the fire extinguishing control panel:

- Duty Mode;
- Fire condition Stage I;
- Fire condition Stage II;
- Disabled component;
- Test;
- Fault condition
- Setup.

### 12.2. Indication

#### 12.2.1. LED and sound indication

No specific LEDs or sound indication is provided for this Mode.

#### 12.2.2. Text messages

The screens visualized on the display are organized in a tree structure, containing subordinate menus (Appendix 2).



Information and Control Mode shows information in the first two lines of the display that are used by Fire condition as a text field to indicate the first line in which the fire extinguishing control panel has entered in fire condition.





Each screen has specific text message referring the operations that are performed in it. The specific text messages are described for the respective screens. .

### 12.3. Using the keypad

Press the button  to enter Information and Control Mode from the screens of Duty Mode, Fire condition, Fault condition, Test Mode and Disabled Component, thus their text messages are suppressed. Where the fire extinguishing control panel operates in combination of Information and



Control Mode and Fault Condition, button  (Alarm) is active too. Where the fire extinguishing control panel operates in combination of Information and Control Mode and Fire Condition, buttons

 (Alarm) and  (Outputs) are active.



Transition to a lower hierarchy menu is performed by the means of button ; to revert to an upper hierarchy menu use button . To switch between elements of one menu use buttons  and .

The screens containing specific information (information screens) or providing the possibility for changing the parameters and executing the commands (command screens) are at the lowest level.

The button  is not active with the information screens as the other three buttons keep their functions. A cursor appears when a screen for changing a parameter or a command screen is activated. In this case the buttons has the following action:

- press the button  to save the changed parameter or to execute the selected command, then the screen is deactivated and the cursor disappears (the different operation of the button in some cases are specifically pointed);
- press the button  to deactivate the screen without saving the changed parameter or without executing the respective command, and the cursor disappears;



- button  is active only in the screens for changing the parameter. Press it to:
  - ◆ move the cursor one position to the right. Upon reaching the last position of the parameter the cursor returns to the first one;
  - ◆ decrease the parameter to the next possible value. Upon reaching the minimal possible value it turns to the maximum value of the class or the parameter;
- button  is active only in the screens for changing the parameter. Press it to increase by one unit the class marked by the cursor or to increase the parameter to its next possible value. In both cases upon reaching the maximum possible value it turns to the minimum value of the class or the parameter.

**12.4. Using the menus**

When the Information and Control Mode is entered the first menu is displayed. It contains the following subordinate menus:

- View Faults
- View Disables
- View Test
- Statuses
- System functions

**12.4.1. Menu View Faults**

The menu is accessible for all Access levels and contains information screens with suppressed messages for fault condition.

From the current status of the fire extinguishing control panel, press button

 to enter the main menu. The cursor „>” is positioned at the first point in the menu.

Press the button  once again to visualize the screen for faults view.

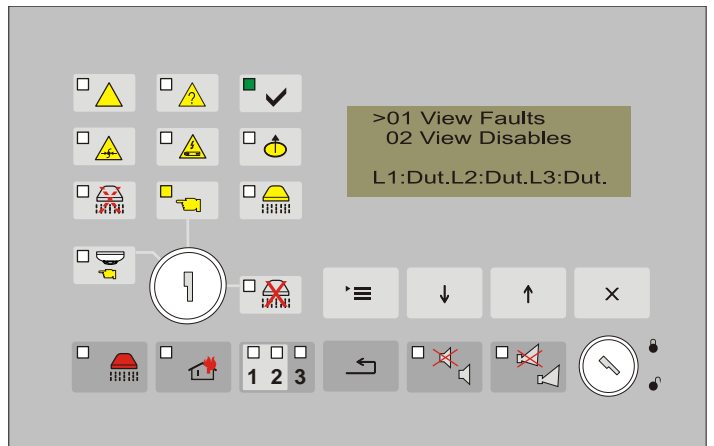

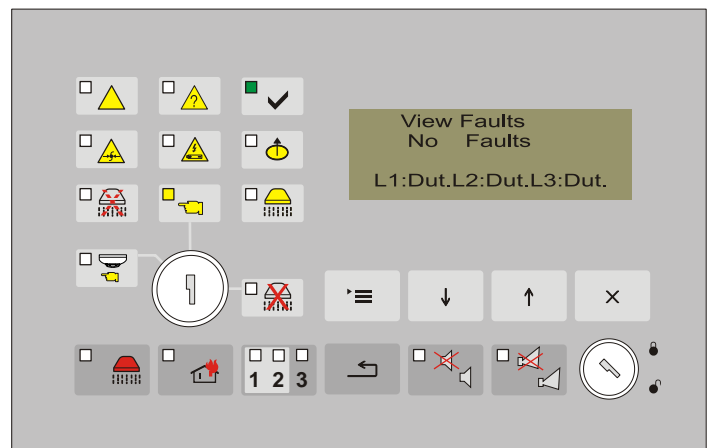

If there are no faults a text message “No Faults” appears on the display.







If there are fault condition the display shows information about the first fault. The screen contains the following information:

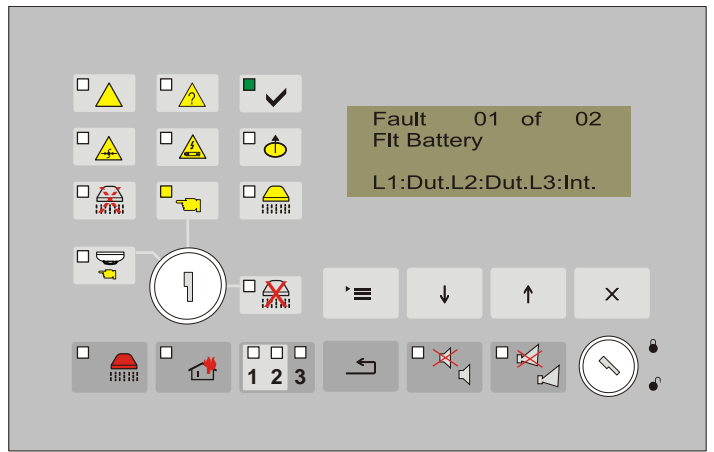

- consecutive number of the fault;
- total number of the faults;
- type of the fault;
- status of the lines

To display the remaining faults (if more than 1), use the buttons  and .

To exit the menu – button .





**Example:** Two fault conditions are registered: fault in the back up battery power supply and interruption of line 3. The common indicator for fault condition  and the specific indicator for power supply fault  are illuminated.

- From the current status of the fire extinguishing control panel press twice button  to display a screen with the first fault (fault in the back up battery power supply);
- Press button  and the display shows the second fault (Fault interruption in line 3);
- To exit the menu, use button .

**12.4.2. Menu View Disables**

The menu is accessible for all Access levels and contains information screens with suppressed messages for the entered disables.

From the current status of the fire extinguishing control panel, press the button  to enter the main menu. The cursor „>” is positioned at the first point of the menu.

Press once the button  and the cursor moves to the second point in the menu.

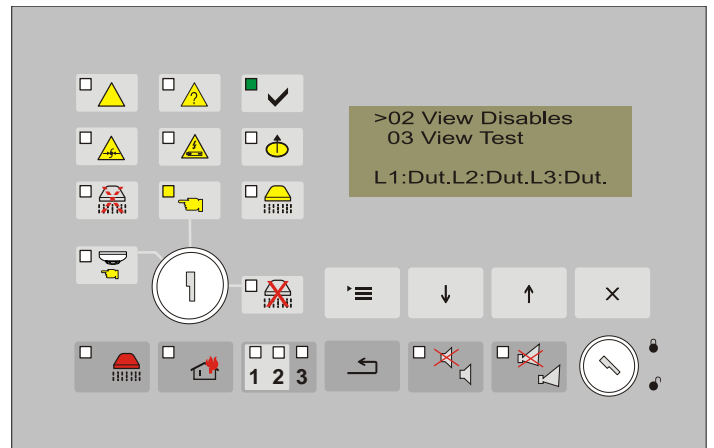

Press the button  to visualize the screen to view the entered disables.

If there are no disabled components the following information screen is displayed.

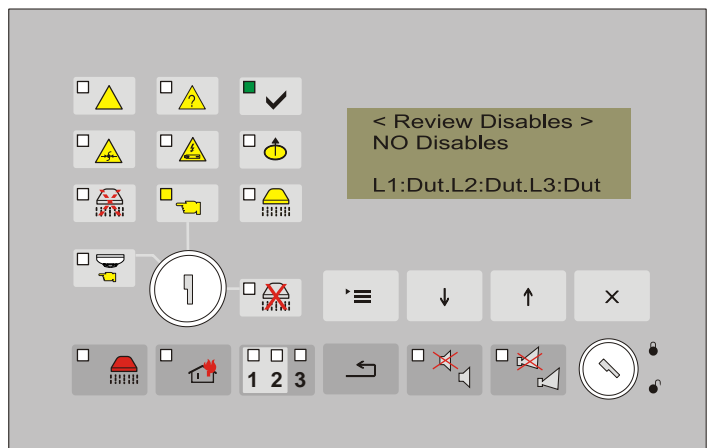

If there are disables all active disables are displayed simultaneously on the screen.

To exit the menu – use the button .

**Example:** All entered disables are visualized on the screen: line1, line 2, line 3, the two relays that are activated for fire condition stage I and stage II and the sounder output for fire condition stage I. As disables are entered for the lines to the last line on the display these disables are also shown in the statuses of the lines.

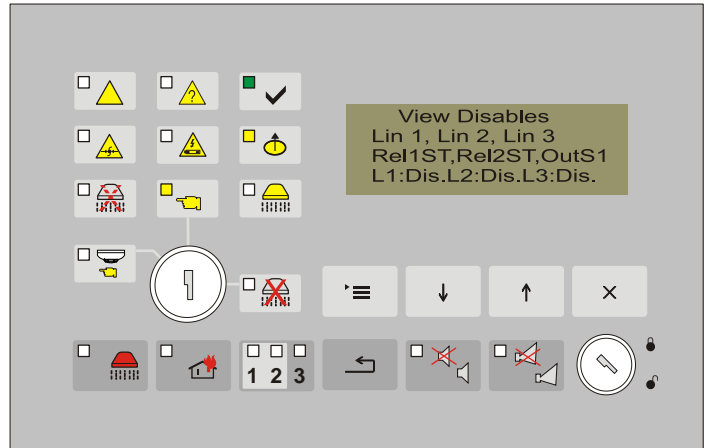



**12.4.3. Menu View Test**

The menu is accessible for all Access levels and contains information screens showing the lines in test.

From the current status of the fire extinguishing control panel, press the button  to enter the main menu. The cursor „>” is positioned at the first point of the menu.

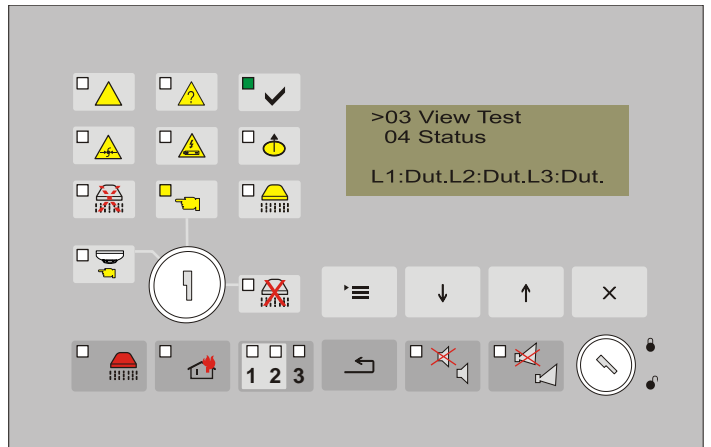
Press button  until the cursor „>” moves to point 03 of the menu.



Press the button  to display the screen to view the lines in test.

If there are no lines in test a text message “No Lines in Test” appears on the display.

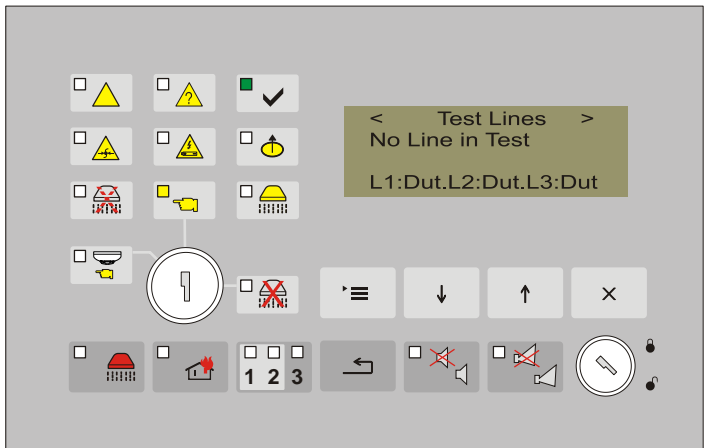

If there is/are line/lines in test, their numbers appear on the display. Information on the changed status is provided on the fourth line of the display.

To exit the menu use button .

**Example:** The displayed screen provides information that Line 1 and Line 2 are set to Test Mode.

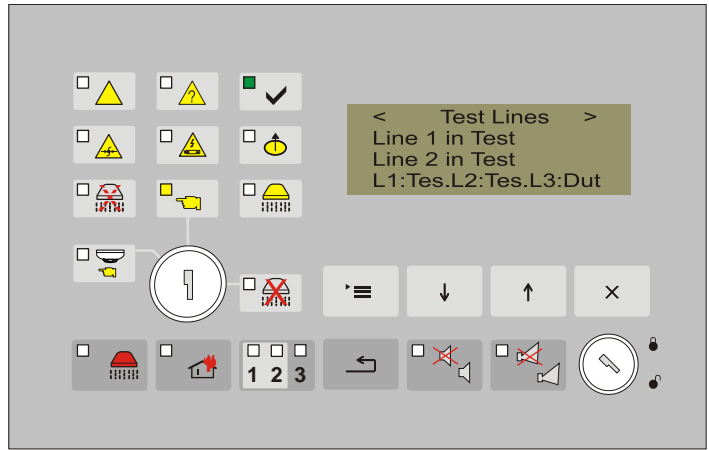



**12.4.4. Menu Statuses**

The menu contains information screen for the statuses of the fire alarm lines, the monitored inputs and outputs. It is accessible for all Access levels.

From the current status of the fire extinguishing control panel, press the button  to enter the main menu. The cursor „>” is positioned at the first point of the menu.

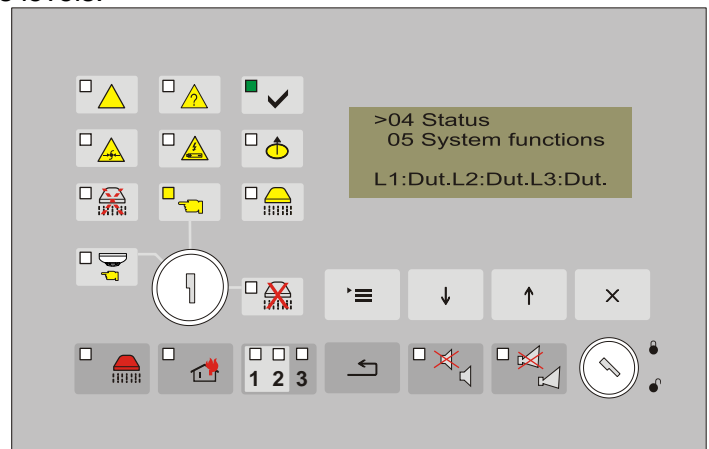
Press button  until the cursor „>” moves to point 04 of the menu.





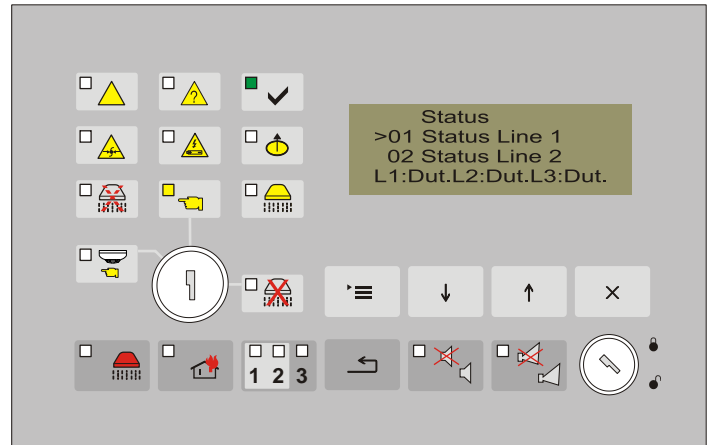

Press the button  to display the subordinate menu. It contains 11 elements, which status could be seen:

- Line 1;
- Line 2;
- Line 3;
- "Manual Release";
- "Mode Select";
- "Hold";
- "On/Off";
- "Low Press";
- "Exting";
- "Sound 1"
- "Sound 2".



The cursor „>” is positioned at the first point of the subordinate menu.

The active buttons are:  and  for moving the cursor in the menu, button  to enter the respective point from the menu and button  for exit.

Information screen containing the line number and the current at that moment is displayed for the status (current condition) of the line. The current value in the line provides information about its status.

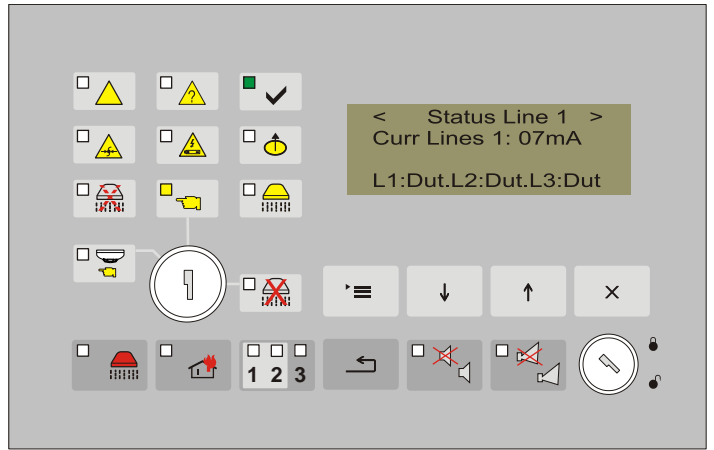

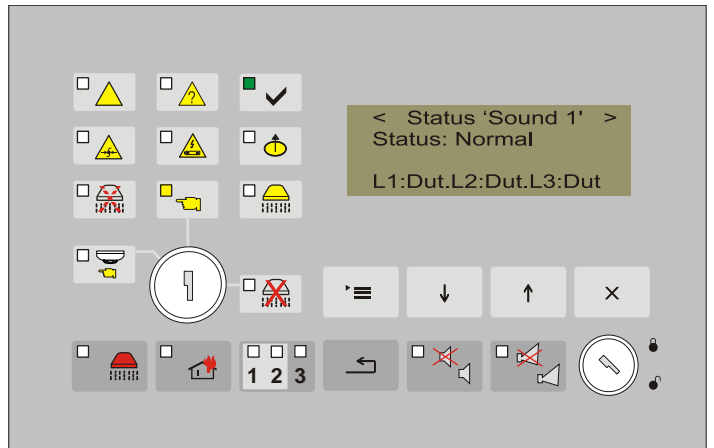

The following statuses are possible for the monitored inputs and outputs:

- Normal – for monitored input or output in normal condition;
- Active - for monitored input or output in active condition;
- Short - for monitored input or output in short circuit;
- Interruption – for interrupted for monitored input or output;



**12.4.5. Menu System Functions**

From the current status of the fire extinguishing control panel, press the button  to enter the main menu. The cursor „>” is positioned at the first point of the menu.

Press button  until the cursor „>” moves to point 05 of the menu.

The menu contains the following subordinate menus and functions (Appendix 2):

- Check LEDs and sound indicators;
- Clock Setup;
- Lines in Test
- Disables
- View Parameters;
- Setup;
- Fire counter;
- View Archive.

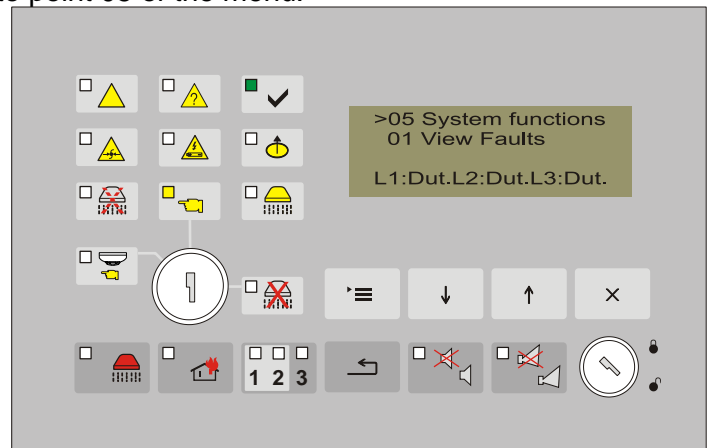

The subordinate menus are accessible at Access Level 2.

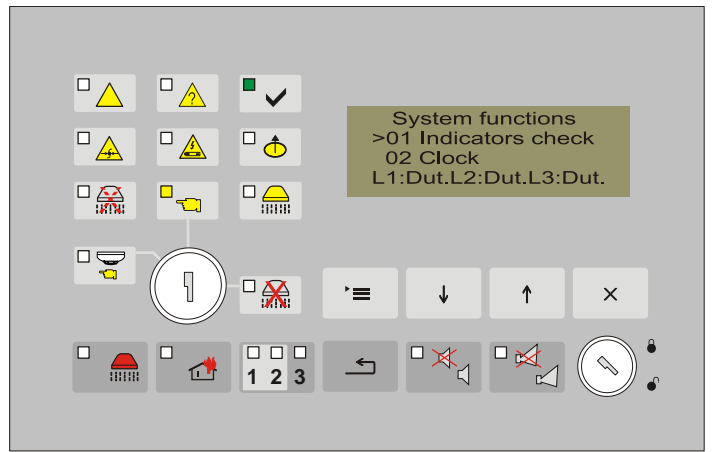

Press button  to enter the subordinate menu.

12.4.5.1. Function Check LEDs and Sound Indicators”



Press the button . All LEDs indicators are illuminated and the sounder produces continuous signal.

Press button  to deactivate the function.

Note: During the check the LEDs of the system error indicator  and the automatic mode indicator  are not illuminated.

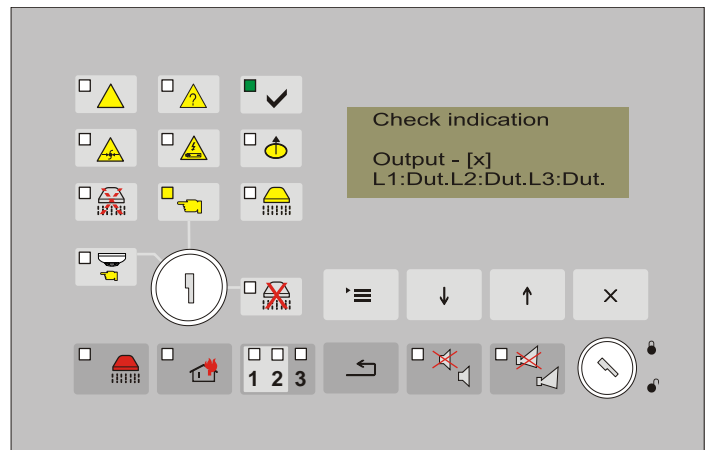

12.4.5.2. Menu Clock Setup

The menu contains the following functions:

- calendar date
- day of the week
- the time
- calibration index

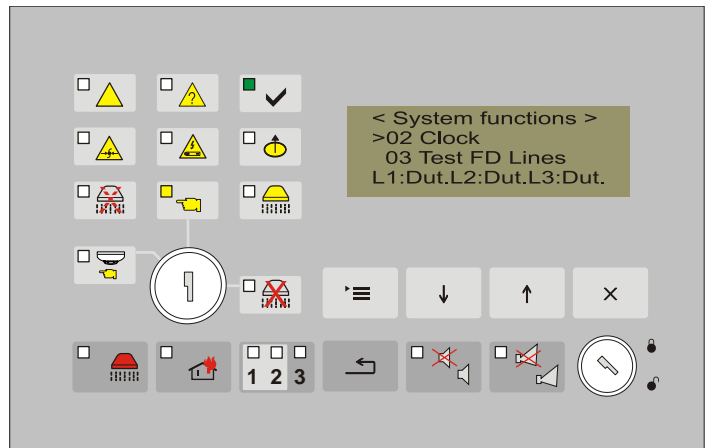



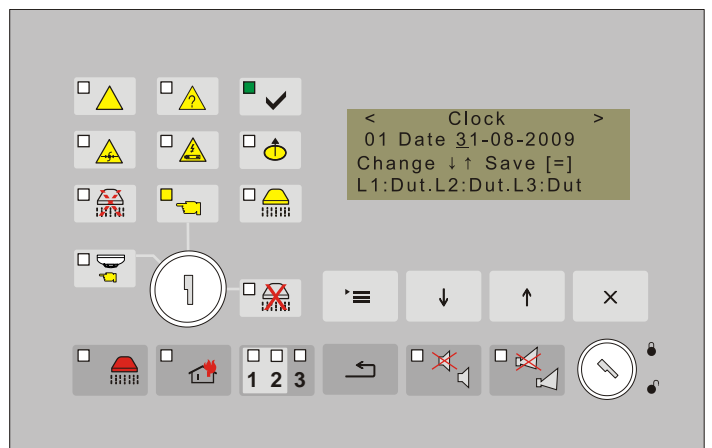

Use the function *Date* to set or adjust the current calendar date.

Upon activation of the function the factory set date appears and the cursor flashes on the first left digit of the date. Admissible values are:

- for the date (two characters, 01÷31)
- for a month (two characters, 0÷12)
- for a year (four characters)







Use:

- button  – to change the calendar date;
- button  – to move to the next character;
- button  – to confirm the entered or set calendar date;
- button  - to exit.

Use Function *Day* to adjust the current day of the week. The field contains the current day.

Upon activation a screen appears with the entered current day of the week.

To change, save the data and to exit the function, use:

- buttons  (Down) and  (Up) for selecting the day (Monday, Tuesday, etc.);
- button  (Menu) – to confirm the entered day;
- button  (Exit).

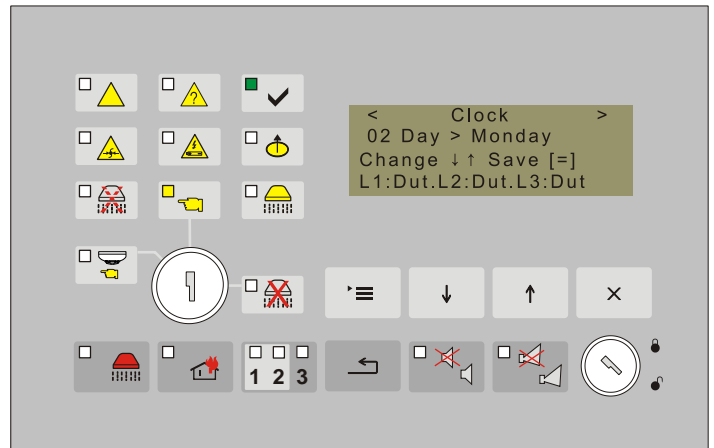





Use Function *Time* to set or adjust the current time.

Upon activation of the function the factory set time appears and the cursor flashes on the first left digit of the hour. Admissible values are:

- for hour (two characters, 00÷23);
- for minutes (two characters, 00÷59);
- for seconds (two characters, 00÷59).

Use:

- button  (Down) – to change the value of the hour;
- button  (Up) – to move to the next character;
- button  (Menu) - to confirm the entered or adjusted date;
- button  (Exit).

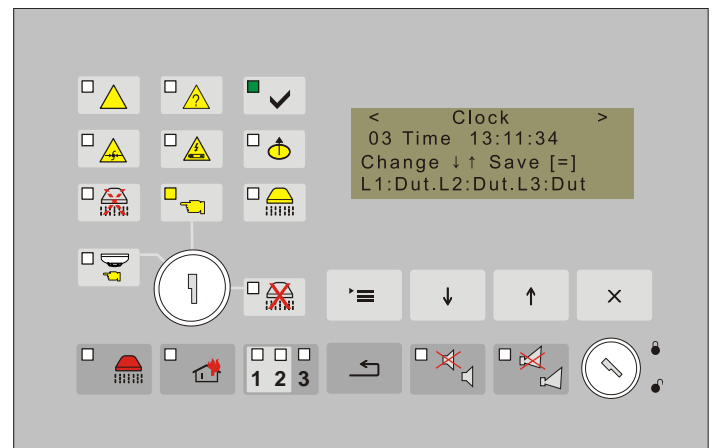

Use function *Calibration* to “accelerate/delay” the clock. Each entered positive unit (“+”) accelerates the clock at the rate of 10,7s per month; each negative unit delays the clock at the rate of 5,35s per month.

The maximum rate is e +5,5min per month or -2,75min per month.

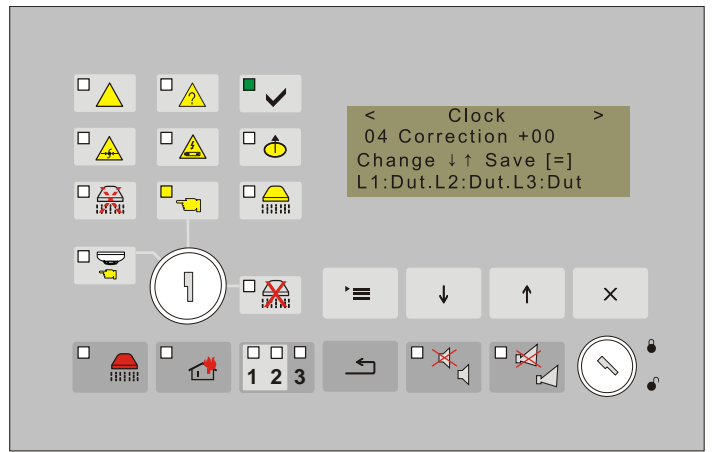



12.4.5.3. Fire Alarm Lines in Test

Use this menu to set each of the three fire alarming lines in Test Mode or to exit that mode.

Upon selection of Test FA Lines, a subordinate menu is entered:

- Test Line 1
- Test Line 2
- Test Line 3

Use the buttons  and  to choose the line to be set to test mode and confirm with button .

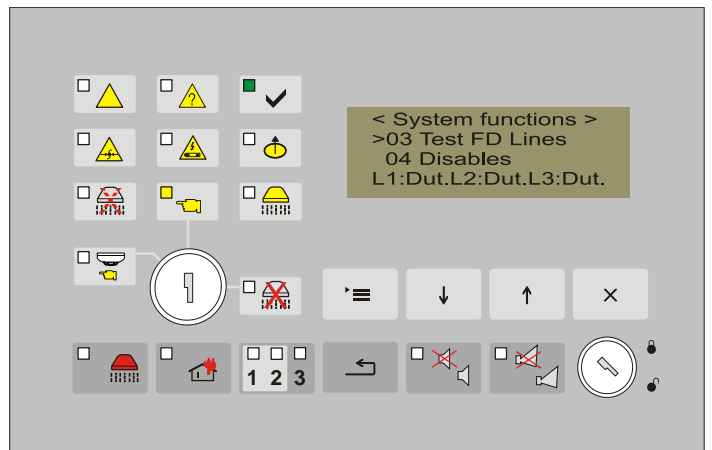

The displayed screen provides the option for alternating change of the parameter Test “ON/OFF”. If it is “ON”, then the respective line is set to test Mode. Use the buttons Up and Down for the change.

Confirm the change of the parameter with button .

A text message “Saved” appears for the stored change.

The status of the line on the fourth line in the display is changed to *Test*.

For exit use button .

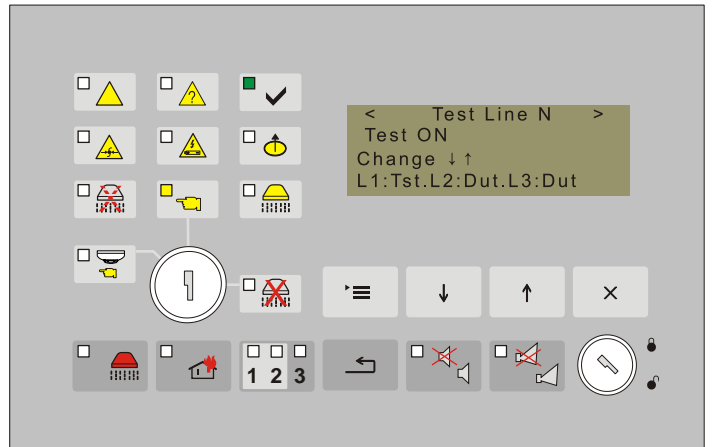



12.4.5.4. Disables

The menu serves to disable/enable the entered disable of fire alarm lines and some outputs of the fire extinguishing control panel. It contains the following functions:

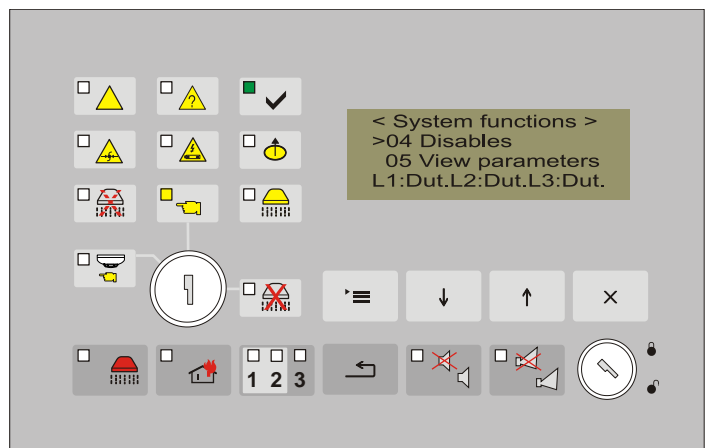
- Disable Line 1
- Disable Line 2
- Disable Line 3
- Disable Rel 1ST
- Disable Rel 2ST
- Disable Output S1



When the function to disable a fire alarm line or an output from the fire extinguishing control panel is selected from the subordinate menu, a screen appears displaying the current status of the disable in the specific input/output. Use the buttons  and  for alternating change the parameter Disable "ON/OFF".

Confirm the change with button , thus it is stored and a text message "Saved" appears on the display.

To exit use the button .

The indicator  illuminates in yellow light. It turns off when all entered disables are cancelled. If the disabled element is a fire alarm line, then the message on the fourth line of the display is changed for the specific line. The text message *Dis* appears for the status.

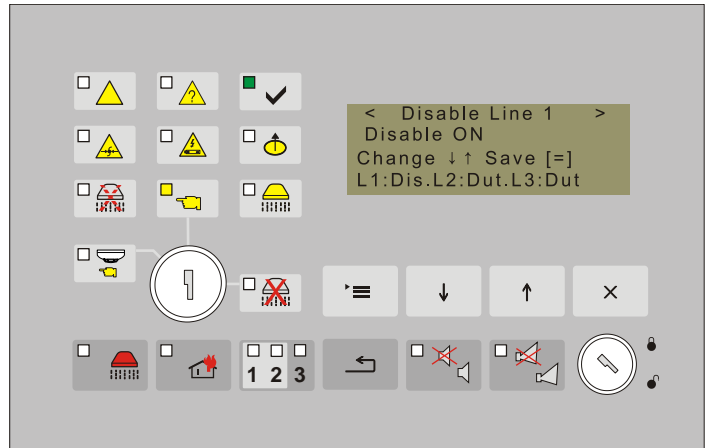

12.4.5.5. Menu *View parameters*

The menu allows the current parameters of the fire extinguishing control panel to be viewed and contains the following screens:

- 01 Lines parameters
- 02 Number of checks
- 03 Check removed FD
- 04 Input Hold
- 05 Input Low Press
- 06 Time Switch Extinguishing
- 07 Evacuation Time
- 08 Check Ground
- 09 RS485 Address
- 10 Software version

The active buttons in the menu and the screens are

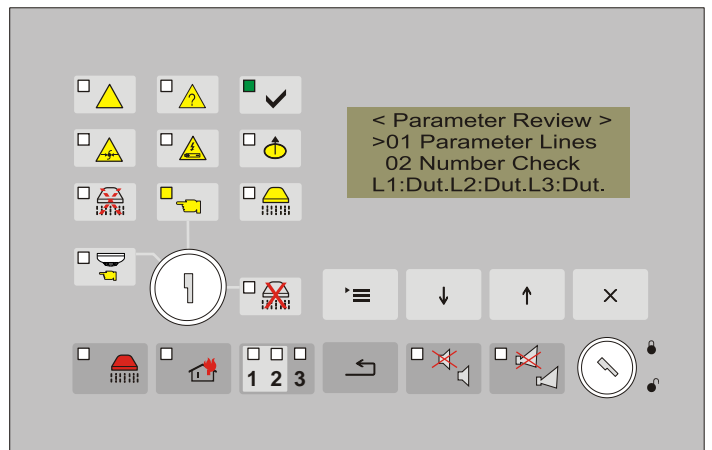

Screen *Lines Parameters* provides information about the value of the current in the lines (short circuit, interruption and fire current).

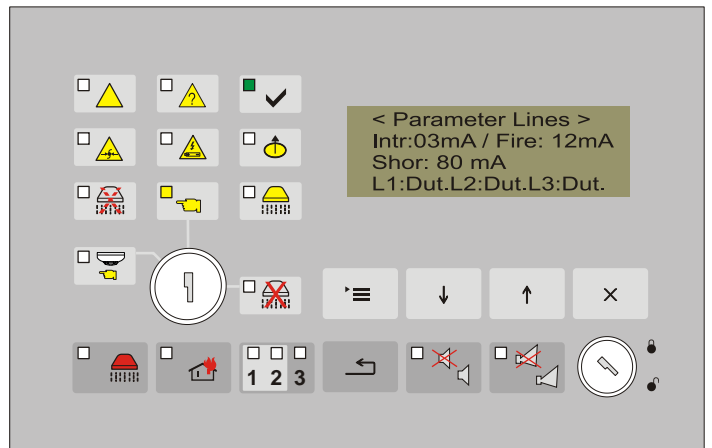



**Screen *Number of Checks***

In order the number of the false activations to be reduced, the fire extinguishing control panel provides the option to setup a parameter indicating the number of the activations of an automatic fire detector within 60 seconds that would trigger the fire extinguishing control panel for fire condition. This screen provides information about the parameter value.

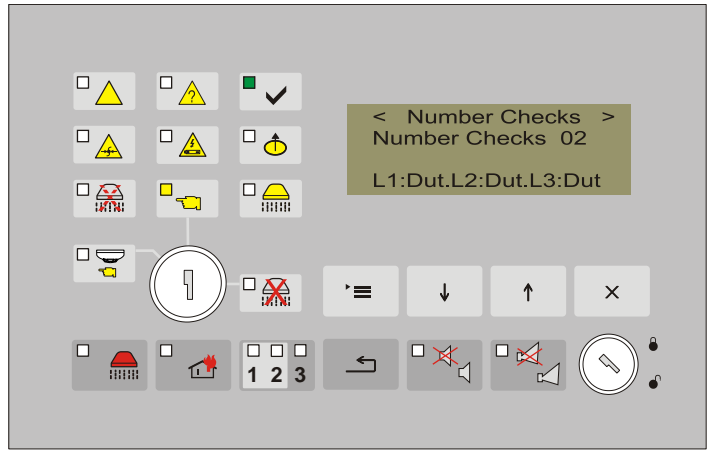

**Screen *Check removed FD***

The fire extinguishing control panel recognizes the fault condition Removed Fire Detector if the bases that are used are diodes. Otherwise the function Removed Fire Detector should be switched off.

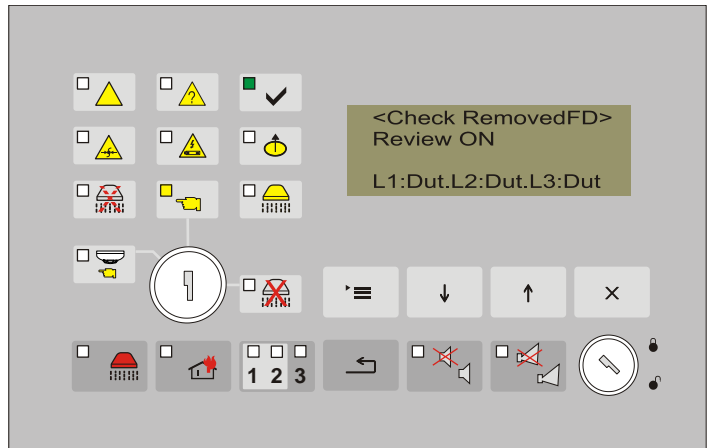

**Screen *Input Hold***

The screen provides information about if the input 'Hold' is active or not and the status of the contacts.

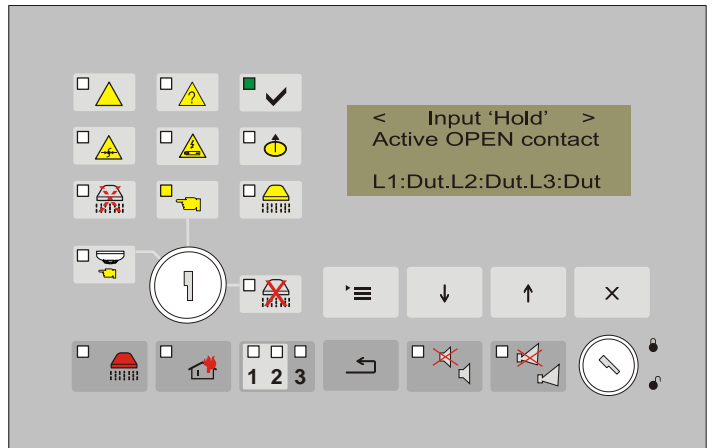

**Screen *Input LowPress***

The screen provides information about if the input 'LowPress' is active or not and the status of the contacts.

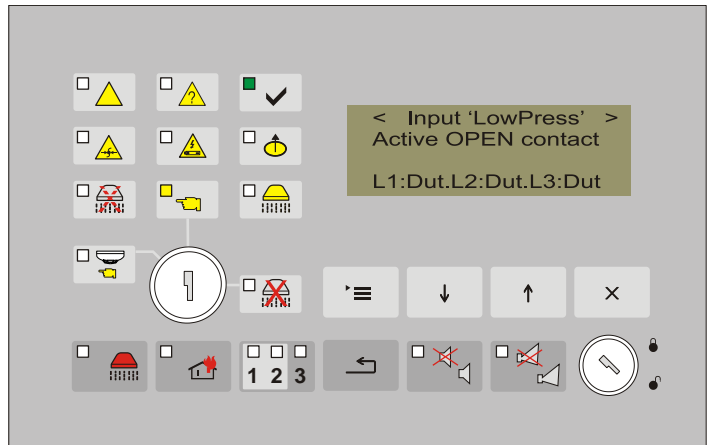

*Screen Time for Extinguishing*

The screen provides information about the setup time while the extinguishing devices are switched. The time is in seconds.

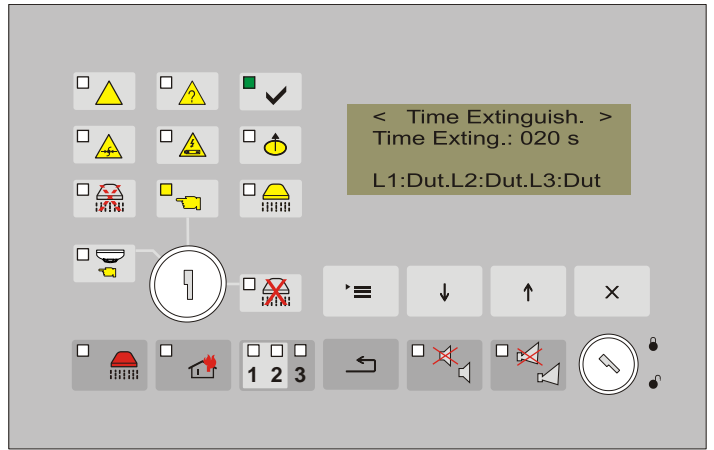

*Screen Evacuation Time*

The screen provides information about the setup time for evacuation. The time is in seconds.

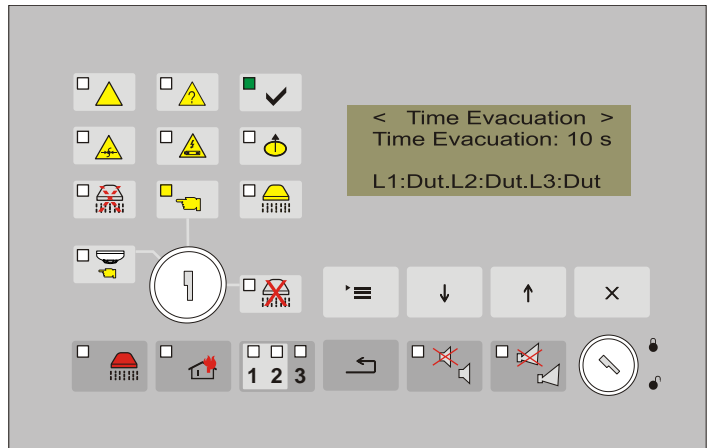

*Screen Check Ground*

The screen provides information if the check for ground is switched.

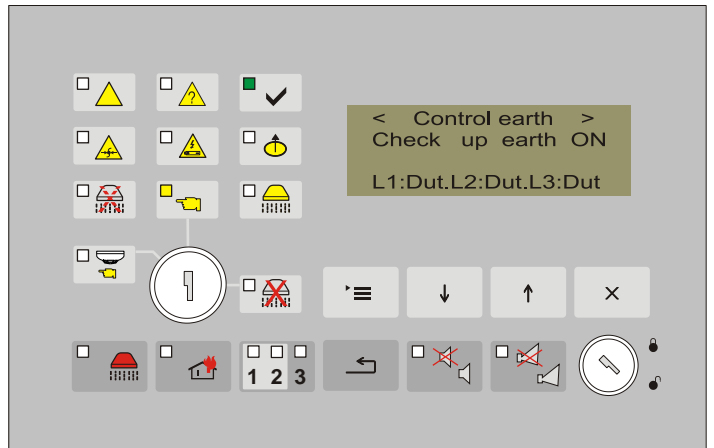

*Screen RS485 Address*

The screen displays the setup network address.

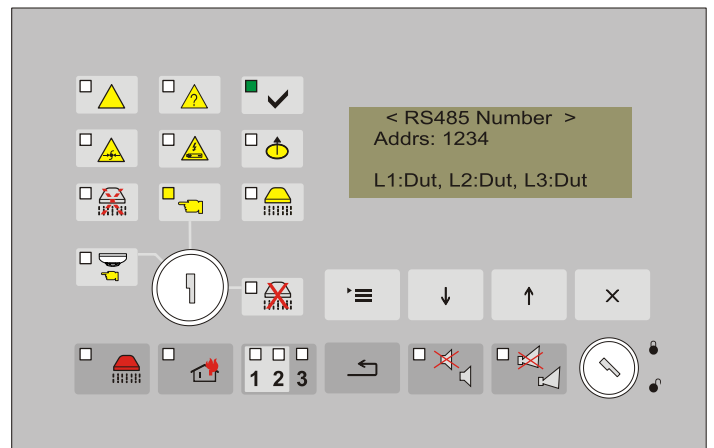

*Screen Software Version*

The screen provides information about the software version.

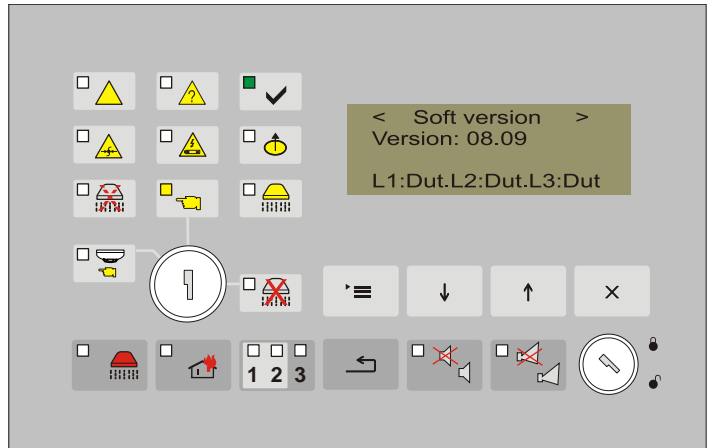

12.4.5.6. *Menu Setup*

The configuration parameters of the fire extinguishing control panel are set in the menu Setup. It is described in details in Setup Mode (section 13).

12.4.5.7. *Screen Fire Counter*

The screen *Fire Counter* is part of the menu *System Functions*.

The active buttons to enter and exit it are

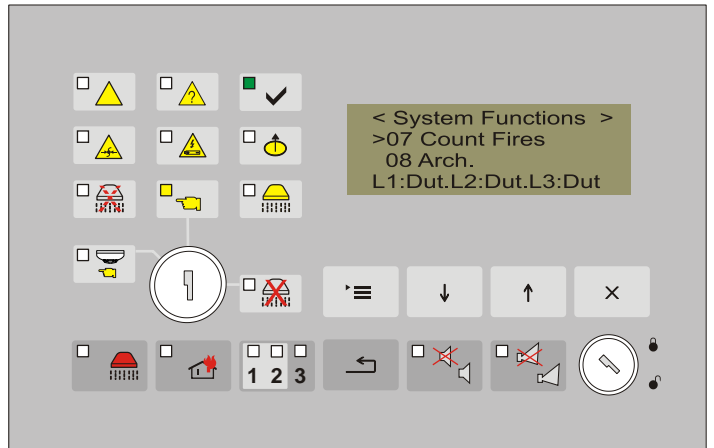

The screen provides information about the entries of the number of times when the fire extinguishing control panel has entered Fire condition.

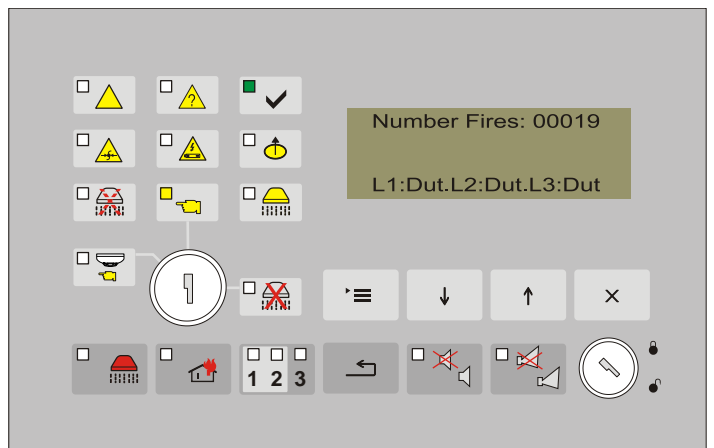

#### 12.4.5.8. Screen Archive

The screen *Archive Counter* is part of the menu *System Functions*.

The active buttons to enter it, to move to another entry in the archive and to exit the screen are:



The information recorded in the archive has the following structure:

- No. of the record;
- Total number of the records;
- Text of the event in the archive (fire condition, initial reset, activated input, etc.);
- Time of the record;
- Date of the record.

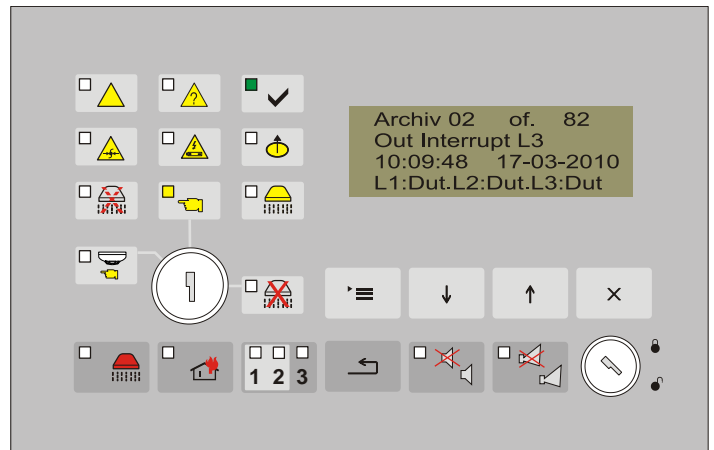

### 13. Setup Mode

#### 13.1. Description

Set Up mode is used for setting the configuration parameters of the fire extinguishing control panel. Access to the Set Up screen is provided through menu *System Functions in Information and Control Mode*.

When the fire extinguishing control panel enters Set Up mode, it exits all other conditions and saves the configuration in its energy independent memory.

Important: In Setup Mode the fire extinguishing control panel discontinues the service of its fire alarm lines, inputs and outputs.

#### 13.2. Indication

##### 13.2.1. LED and sound indication

In Set Up mode only the green LED indicator  (*Power supply*) is illuminated. The local sounder is off.

##### 13.2.2. Text message

The text message shown on the display is specific for each menu, function or screen. The screens with the respective text message for each of the setup parameter are given in the part describing the operation in menu Setup.

#### 13.3. Using the keypad



Setup Mode requires Access Level 3. It is necessary:





- The switch to be in position  ;
- To enter a password.

The text messages in this mode are organized in a tree structure, of main and subordinate menus.

Press the button  to enter Setup Mode from the screens of Duty Mode, Fire condition, Fault condition, Test Mode and Disabled Component, thus their text messages are suppressed. Where the fire extinguishing control panel operates in combination of Setup Mode and Fault Condition, button







(Alarm) is active too. Where the fire extinguishing control panel operates in combination of Setup Mode and Fire Condition, buttons  (Alarm) and  (Outputs) are active.

Transition to a lower hierarchy menu is performed by the means of button ; to revert to an upper hierarchy menu use button . To switch between elements of one menu use buttons  and .

The screens containing specific information (information screens) or providing the possibility for changing the parameters and executing the commands (command screens) are at the lowest level.

The button  is not active with the information screens as the other three buttons keep their functions. A cursor appears when a screen for changing a parameter or a command screen is activated. In this case the buttons has the following action:

- press the button  to save the changed parameter or to execute the selected command, then the screen is deactivated and the cursor disappears (the different operation of the button in some cases are specifically pointed);
- press the button  to deactivate the screen without saving the changed parameter or without executing the respective command, and the cursor disappears;
- button  is active only in the screens for changing the parameter. Press it to:
  - ◆ move the cursor one position to the right. Upon reaching the last position of the parameter the cursor returns to the first one;
  - ◆ decrease the parameter to the next possible value. Upon reaching the minimal possible value it turns to the maximum value of the class or the parameter;
- button  is active only in the screens for changing the parameter. Press it to increase by one unit the class marked by the cursor or to increase the parameter to its next possible value. In both cases upon reaching the maximum possible value it turns to the minimum value of the class or the parameter.



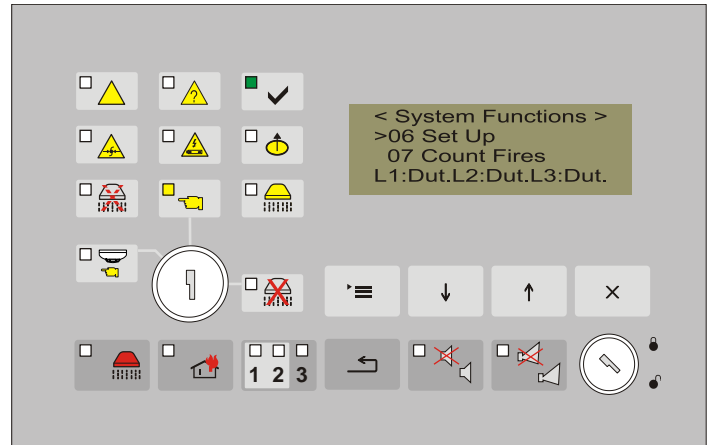

### 13.4. Using the menus

Enter Setup Mode through menu System Function.



Enter a password (four-digit number) to have an access to the menu. The factory set password is "0000".

Use:

- button  (Down) – to change the character;
- button  (Up) – to move to the next character;
- button  (Menu) – to confirm the entered password;
- button  (Exit).

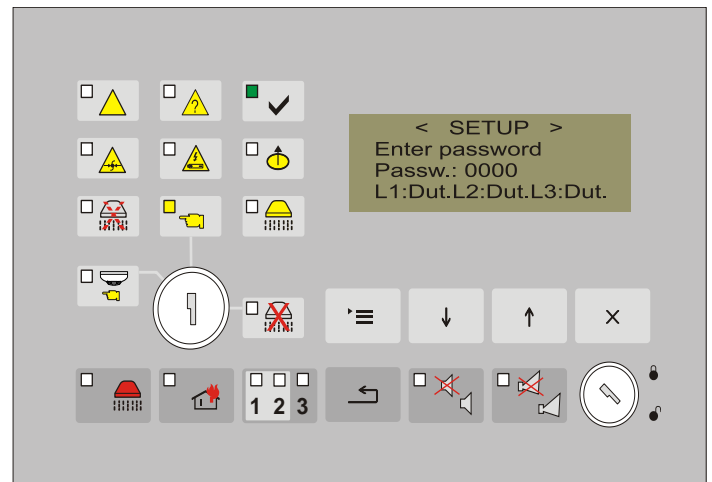

The menu has the following subordinate menus

- |                                      |   |
|--------------------------------------|---|
| 01 Fire Extinguishing Control Panel: | RS485 address (section 13.4.1.1)                |
|                                      | RS485 On/Off (section 13.4.1.2)                 |
|                                      | Language (section 13.4.1.3.)                    |
|                                      | Check Ground (section 13.4.1.4.)                |
| 02 CAN Settings                      | CAN On/Off (section 13.4.2.1.)                  |
|                                      | Text message (section 13.4.2.2.)                |
|                                      | CAN speed (section 13.4.2.3.)                   |
|                                      | CAN Address (section 13.4.2.4.)                 |
|                                      | CAN AddressRem.Panel (section 13.4.2.5.)        |
|                                      | CAN Rem.Inputs (section 13.4.2.6.)              |
|                                      | Number FD FuncAnd (section 13.4.2.7)            |
| 03 Input/Outputs                     | Current fire alarm lines (section 13.4.3.1.)    |
|                                      | Number of checks of lines (section 13.4.3.2.)   |
|                                      | Check removed fire detector (section 13.4.3.3.) |
|                                      | Input Hold (section 13.4.3.4.)                  |
|                                      | Input Low Press (section 13.4.3.5.)             |
| 04 Extinguishing time                |   |
| 05 Evacuation time                   |   |
| 06 Factory settings                  |   |
| 07 Clear Archive                     |   |
| 08 New password                      |   |

#### 13.4.1. Menu Fire Extinguishing Control Panel

The menu includes the functions for setting the parameters: network address, language and if the function check ground is active or not.

13.4.1.1. The value of the parameter Network Address defines uniquely the fire extinguishing control panel within the established network of remote control panels and repeaters.



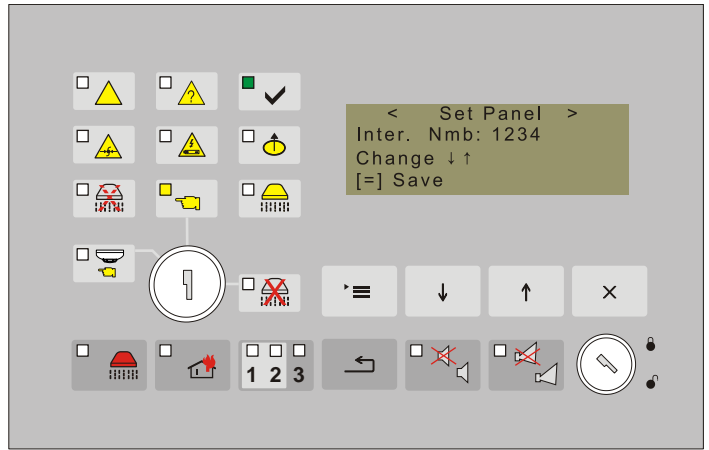

A screen for entry of the data appears in setting (entry) of a network address.

The permissible values of the network address are from 0000 to 9999.

The value of the default parameter is „1234”.







Use:

- button  (Down) – to change the character;
- button  (Up) – to move to the next character;
- button  (Menu) – for confirmation;
- button  (Exit).

When the parameter is changed and the new value is saved with the button  a text message “Saved!” appears! Exit – [x]”.

13.4.1.2. To set ON or OFF RS485 Network Parameter permits values ON of OFF



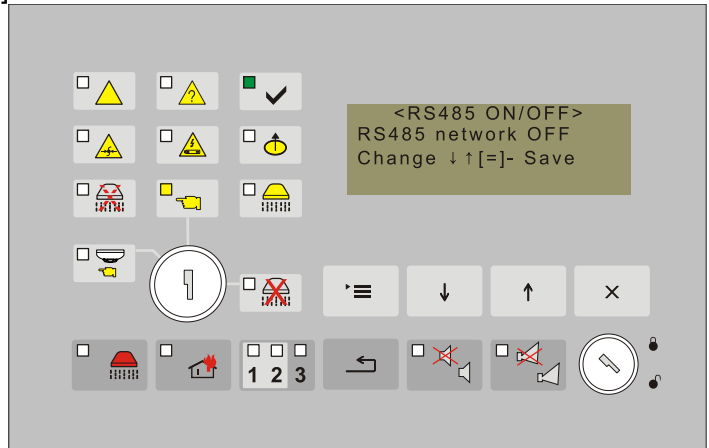

Active buttons :

- to change - buttons  and  ;
- to save the change - button  („Menu”);
- to exit press - button  („Exit”).



13.4.1.3. The fire extinguishing control panel supports menus and screens in two of three languages:

- Bulgarian;
- English;
- Russian.

Use the buttons  (Down) and  (Up) for alternating change of the language, confirm the new value of the parameter using the button  and the button  to exit it.

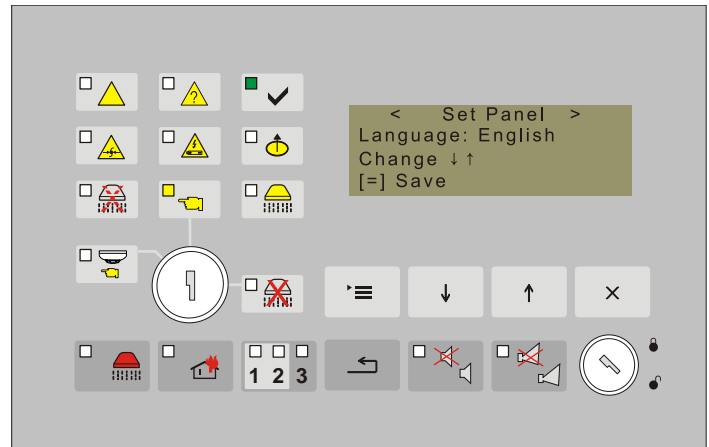





When the parameter is changed and the new value is saved with the button  a text message “Saved!” appears! Exit – [x]”. The fire extinguishing control panel is factory set to English language.

#### 13.4.1.4. Function *Check Ground*

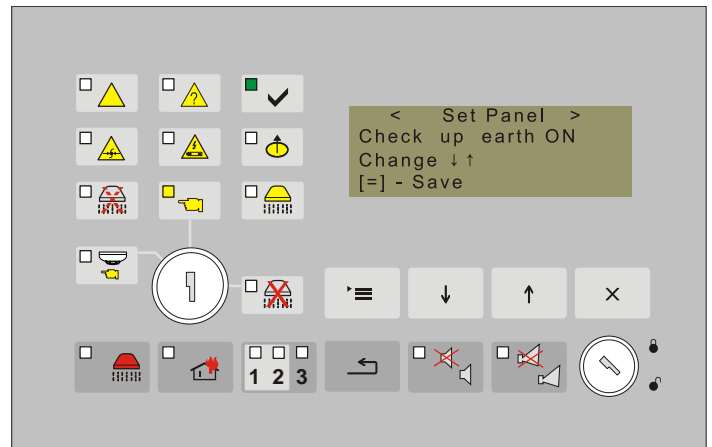
The screen provides the possibility to indicate if check ground is being performed or not. Check ground is disabled only if Zener barriers or other devices that might cause ground fault are used however that disable does not have an effect on the functions of the of the fire extinguishing control panel. The factory setting of this parameter is Check Ground ON.

The admissible values are – Check Ground ON or OFF.



Use the buttons  (Down) and  (Up) to change alternatively the parameter, the button  to confirm the new value and the button  to exit.

#### 13.4.2. Menu “CAN Parameters”

Fire extinguishing Control Panel communicates in a network on CAN interface with the devices from IFS7000 as transmitting and receiving information. It is necessary for the programable software of the panel to be 13.10 version or higher.

Functionality:

- Connected in network, FS5200E operates with up to 8 Control panels (Remote control panels) of series 7000.
- It is necessary for the local network to operate with at least 1 panel from series 7000;
- Only the panel from 7000 series is defined as the main panel;
- Information of Fire condition or Fault condition of FS5200E is accepted and indicated only from panels 7000 series;
- Maximum number of devices on CAN network - up to 32 ( i.e maximum laden network can be built of 8 panels series 7000 and 24 FS5200E panels.

Communication

Communication “FS5200E → IFS7000”

• In **Fire** condition of FS5200E, 3 types of conditions are transmitted and indicated of all the panels series 7000:

- FIRE Condition Stage 1;
- FIRE Condition Stage 2 evacuation;
- FIRE Condition Stage 2 exting.ON

• In **Fault** condition of FS5200E the following conditions are indicated and transferred into the panels series 7000:

- Fault in Fire detector of Line 1;
- Fault in Fire detector of Line 2;
- Fault in Fire detector of Line 3;
- Fault in Manual Release Mode;
- Fault in Line Mode;
- Fault in Line Disable Extinguishing;
- Fault in Line Low Pressure;
- Fault in Line Hold Extinguishing;
- Fault in Exit Extinguishing;
- Fault Exit Fire Stage 1;
- Fault Exit Fire Stage 2;
- Fault in Back up battery supply;
- Fault in Mains supply

Communication "5200E ← IFS7000”



- Fire Extinguishing Control Panel 5200E receives and uniquely distinguishes data from activated inputs of up to 5 manual call points (FD7150), up to 8 automatic fire detectors (FD71xx) and inputs of devices FD7203 within the systems series 7000. Inputs can be configured to all of the Control Panels of type 7000 included into the network.
- Fire Extinguishing Control panel 5200E receives and single-distinguishes data from activated inputs of device FD7203. Inputs could be configured to all Control Panels of series 7000, connected in the network.
- 4 inputs can be configured in the 5200E Control Panel, these inputs affect the functions of the extinguishing algorithm.  
 Inputs are for the following functions :
  - Manual Extinguishing Activation (by means of a manual call point) or automatic (by means of an automatic fire detector);
  - Disable Extinguishing;
  - Switches to Manual / Manual Automatic Mode;
  - Hold Extinguishing.
- In 5200E Fire condition can be reset from the display of panels series 7000. The reset Panel transmits information to all the panels of (7000 series) for resetting of Fire Condition.
- Sound indicator can be suppressed from the IFS7002 display in case of Fire or Fault Condition in the Extinguishing panel.
- In case of disconnected communication, the Control Panel FS5200E registers fault condition „Fault CAN” („Fault RS485”).



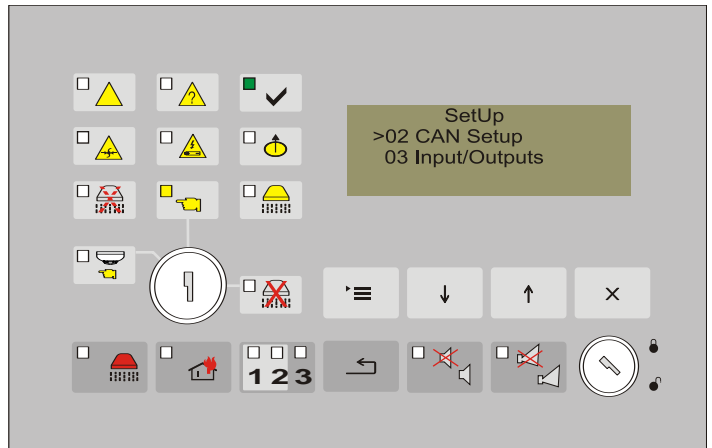

In the menu “CAN Parameters” set the parameters for operating on CAN network, together with 7000 serie (the programable softwear of the panel should be 13.10 version or higher).

Menu contains the following positions:

01. CAN On/Off
02. Text message
03. CAN speed
04. CAN Address
05. CAN AddressRem.Panel
06. CAN Rem.Inputs
07. Numb FD FuncAnd



13.4.2.1. To set ON or OFF CAN Network Parameter permits values ON of OFF  
 Active buttons :



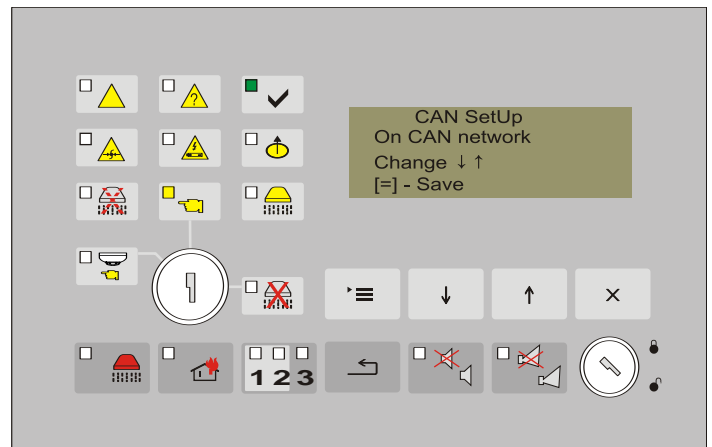

- to change - buttons  and  ;
- to save the change - button  („Menu”);
- to exit press - button  („Exit”).



13.4.2.2. To enter text message.

The screen allows the user to enter a text message for identifying the Control Panel (name) within 20 characters - Cyrillic and Latin. If an event occurs (Fault condition or Fire Condition), the text is shown on the display of the panels series 7000.

Active buttons:

- to change the character –  ;
- to position the next character  ;
- to save the text - button  ;
- to exit - button  („Exit”).

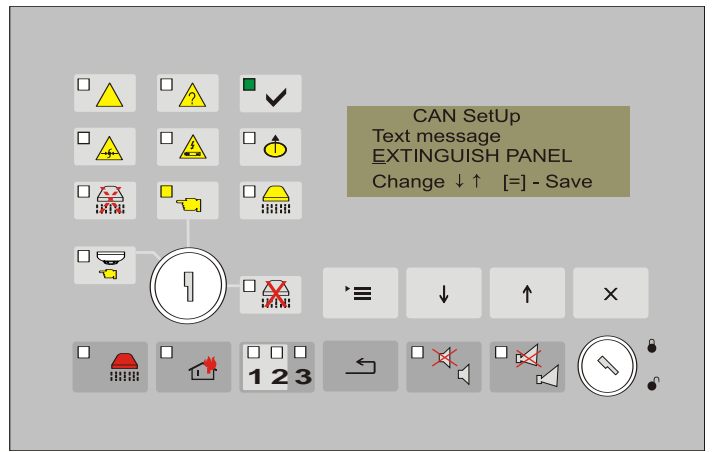





13.4.2.3. Set Up speed on CAN network communication.

Enter in the screen the exchange rate of the network.

Important : The speed entered for Panel FS5200E must correspond to the speed, entered for IFS7000 panels.

Parameter permits the following values: 40, 80, 100 или 160 kb/s.

Active buttons:

- to change – buttons  and  ;
- to save the change - button  („Menu”);
- to exit - button  („Exit”).

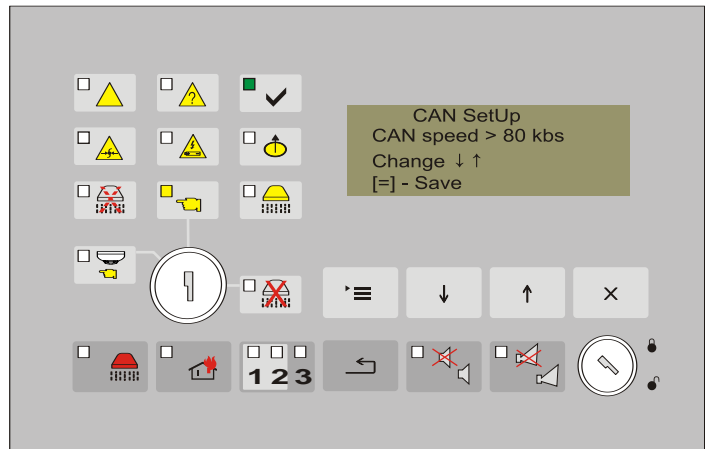

Recommendation :





If the length of the wire network is longer than 500 meters, recommended speed is 40 kb / s.

13.4.2.4. Setting network address of FS5200E panel.

Set the address of the Panel on the screen. Address must be unique.

Admissible values: 01÷31.

Active buttons:

- to change - buttons  and  ;
- to save the change - button  („Menu”);
- to exit - button  („Exit”).

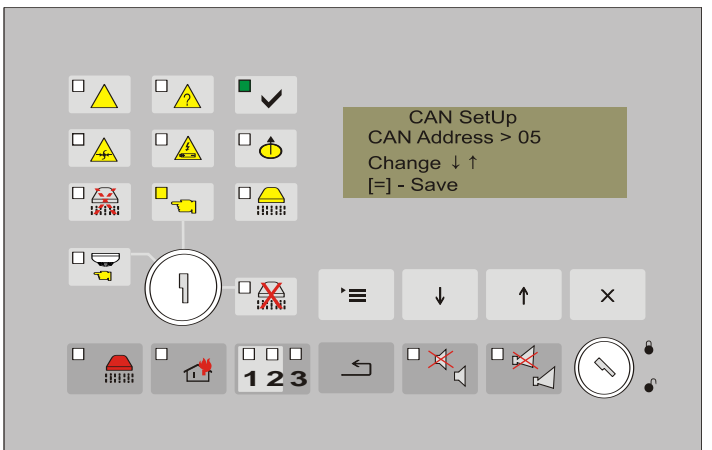

Notice:

CAN address value has no connection with "Master/Slave" Setting.

13.4.2.5. Inserting addresses of the Remote Control Panels.

This option of the Menu permits entering the addresses in the Remote Panels for communication with FS5200E.



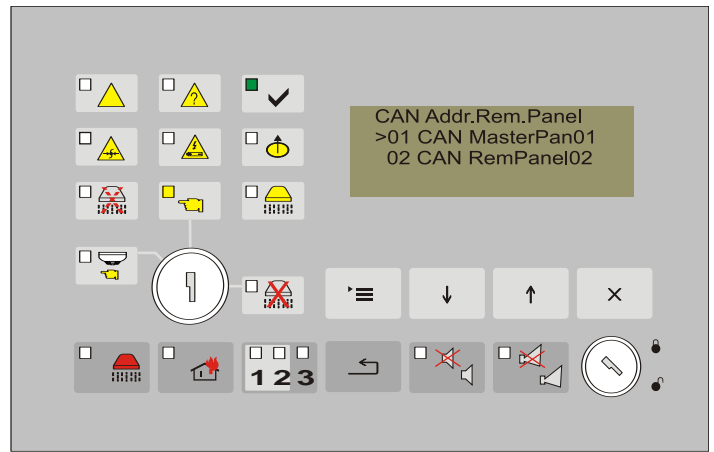

Menu includes :

- 01 CAN Master Remote Panel 01;
- 02 CAN Remote Panel 02;
- 03 CAN Remote Panel 03;
- 04 CAN Remote Panel 04;
- 05 CAN Remote Panel 05;
- 06 CAN Remote Panel 06;
- 07 CAN Remote Panel 07;
- 08 CAN Remote Ranel 08;



In article 1 of the subordinate menu enter the address of the "Master" panel. The panel is required to be from series 7000.

Active buttons:

- to change – buttons  and  ;
- to save the change - button  („Menu”);
- to exit - button  („Exit”).

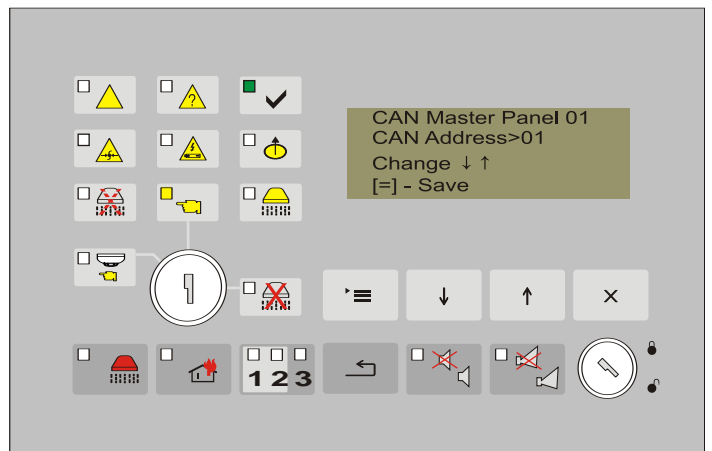

In articles 02÷08 from the Menu, insert by analogical order the addresses of the other control panels series 7000, communicating with the Extinguishing Panel.

The addresses of the Remote panels are to be entered in ascending order. (RP1, RP2, RP8 ...).

**Important:** If the number of the control panels series 7000 is less than 8, then in the spaces for addressing panels, which are not in use save Address "00" (entered by default)

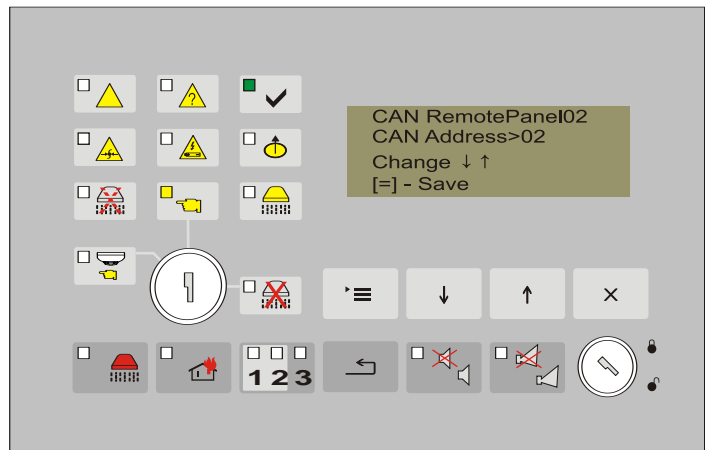

13.4.2.6. If devices of type FD7203, manual or automatic detectors are also used as an input of the fire Extinguishing Panel, their parameters must be set in FS5200E.

Four inputs of the Control Panel are possible to be set :

- 01 Input Manual Activation;
- 02 Input Autom.Activation
- 03 Input Manual/automatic Mode;
- 04 Input Disable Extinguishing;
- 05 Input Hold Extinguishing.

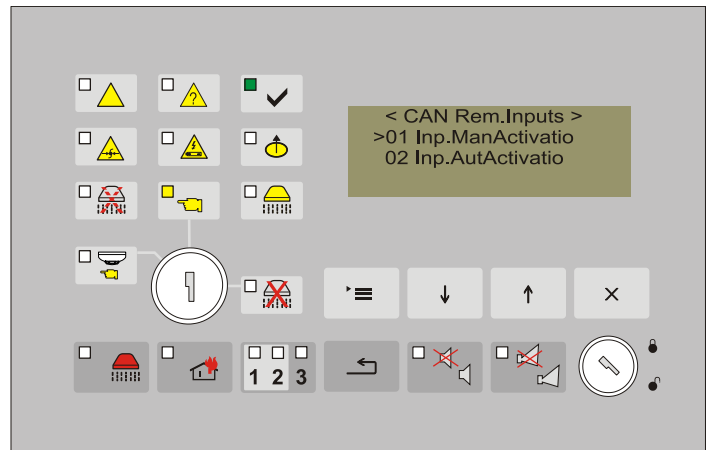

13.4.2.6.1. Input Manual Activation includes the opportunity for activation from manual call point type FD7150, of system series 7000, operating in a common network together with Fire Extinguishing Control Panel. Insert data for the address of the Control Panel, the address of the loop and the address of the manual call point. The admissible number of manual call points that can be included is 5.

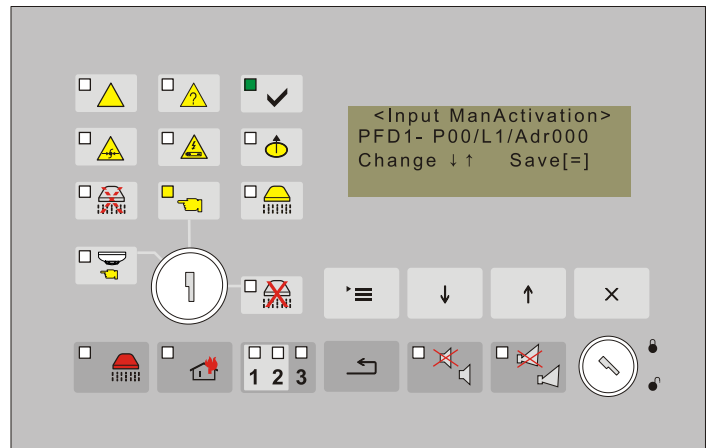

13.4.2.6.2. Input Automatic Activation includes the opportunity for activation from automatic fire detectors type FD71XX, of system series 7000, operating in a common network together with the Fire Extinguishing Control Panel. Insert data for the address of the Control Panel, the address of the loop and the address of the manual call point in the loop. The admissible number of automatic fire detectors that can be included is 8. In factory setting at least two of them are connected in logical dependency "AND" (item.13.4.2.7).

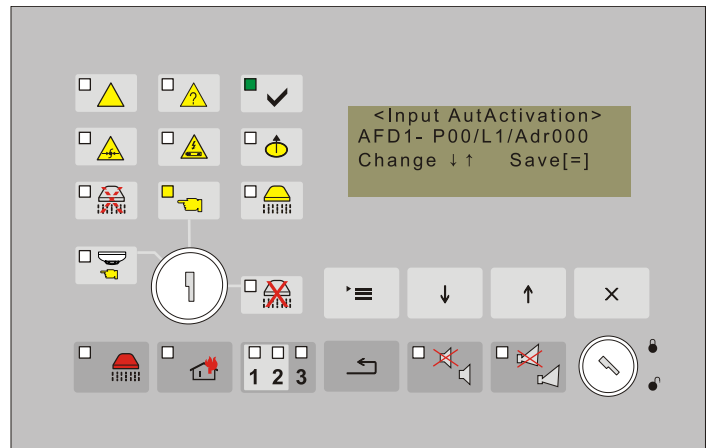

13.4.2.6.3. Inputs „Mode Manual/Automatic”, „Disable Extinguishing” and „Hold Extinguishing” are to be set by the same procedure.





Setting targets uniquely distinguishing which input, of what type FD7203 device, from which loop, and of which Control Panel the command impact will come the the Extinguishing Panel and it includes the following items:

- 01 On/Off.Rem.Input;
- 02 Number Remote Panel;
- 03 Number Loop;
- 04 Number Device 7203;
- 05 Number Input 7203.

13.4.2.6.3.1. ON/OFF Remote input.

Admissible values of the parameter are : "On" and "Off"

Active buttons :



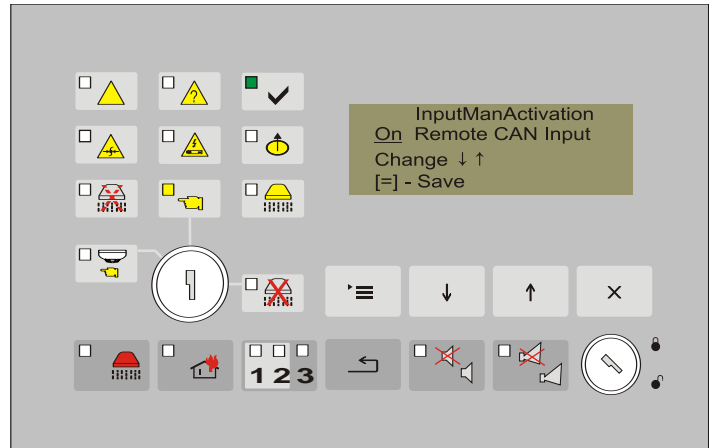

- to change – buttons  and  ;
- to save the change – button  („Menu”);
- to exit - button  („Exit”).



13.4.2.6.3.2. Address of the Remote Panel, where the device FD7203 is situated.

Admissible values of the parameter are : 01÷31(i.e the addresses of Control Panels in the network).

Active buttons :



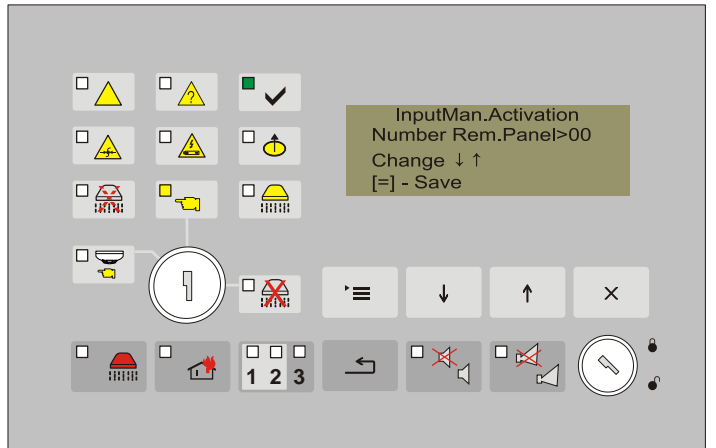

- to change – buttons  and  ;
- to save the change – button  („Menu”);
- to exit - button  („Exit”).



13.4.2.6.3.3. Number of a loop where the FD7203 device is situated.

Admissible values of the parametre are 01 and 02.

Active buttons :



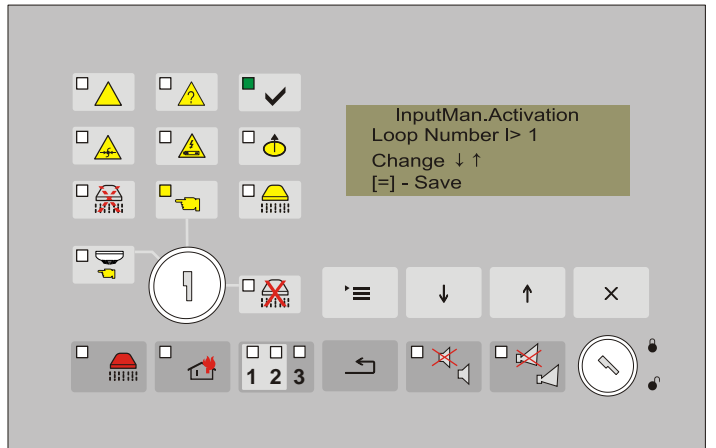

- to change – buttons  and  ;
- to save the change – button  („Menu”);
- to exit - button  („Exit”).



13.4.2.6.3.4. Number of the addressable device FD7203.

Admissible values of the parameters are: 01÷125 (address of the device in the relevant loop).

Active buttons :



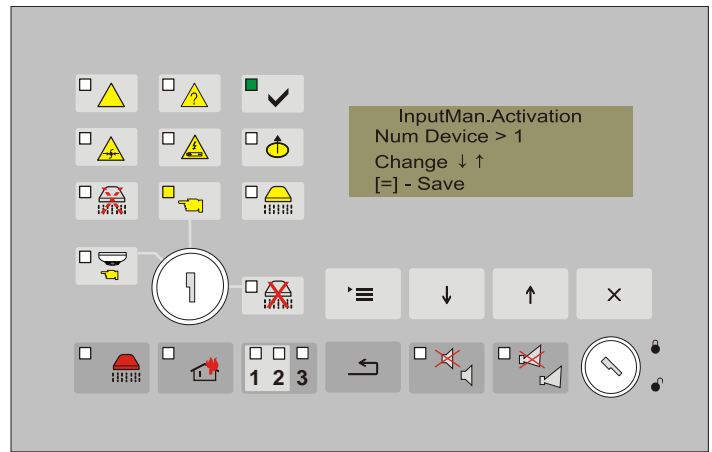

- to change – buttons  and  ;
- to save the change – button  („Menu”);
- to exit - button  („Exit”).



13.4.2.6.3.5. Number of the input of the addressable device FD7203.

Admissible values of the parameter are 01, 02 and 03 (IN1, IN2 and IN3 of FD7203).

Active buttons :

- to change – buttons  and  ;
- to save the change – button  („Menu”);
- to exit - button  („Exit”).

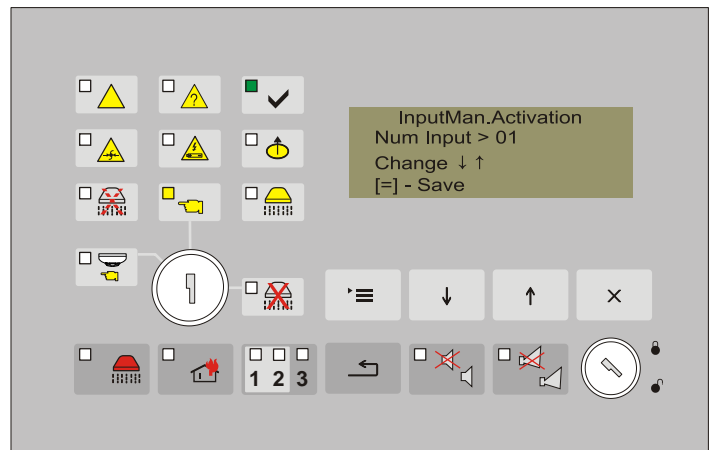

The procedure for inserting parameters for inputs "Manual/AutomaticMode", "Disable Extinguishing" and "Hold Extinguishing" is performed analogically according to the described in articles 13.4.2.6.3.1.÷13.4.2.6.3.5. and operations.

13.4.2.7. Insert the number of the automatic fire detectors of type FD71XX, connected in logical dependency „AND”. The inserted number indicates how many fire detectors should be activated in order the control panel to enter Fire Condition 2<sup>nd</sup> Stage .

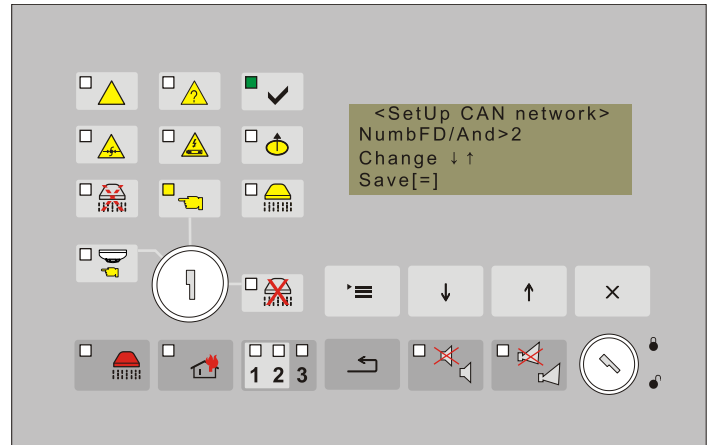

### 13.4.3. Menu *Input/Outputs*

This menu includes the setting of the following parameters:

- current of fire alarm lines
- number of checks for accepting the signal for fire condition from a fire detector
- checking the lines for removed fire detector
- setting the input Hold
- setting the input Low Press





#### 13.4.3.1. Function *Current of Fire Alarm Line*

The screen provides the option to set the current value of the fire alarm lines when interruption and fire condition is registered. The interruption threshold could be set within the range 3 to 12 mA, and for fire condition – from 12 to 60 mA. The difference between the two conditions provides the screen for Duty Mode.

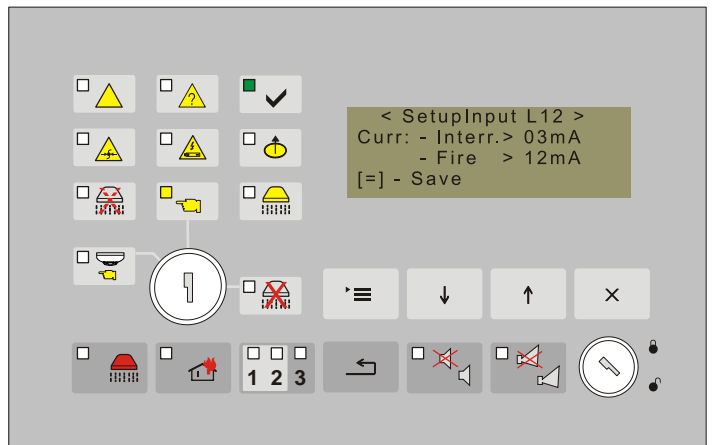
The factory setting is 3 and 12 mA for interruption and fire condition respectively.

The active buttons are:







- button  – to change the character (e.g.: 03, 04 .....);
- button  (Up) – to pass from setting the current of interruption to setting the current of fire;
- button  (Menu) – to confirm the changes;
- button  (Exit) – to exit the function.

13.4.3.2. Screen *Number of Checks of Lines*

Use this screen to set the number of checks upon which the fire extinguishing control panel registers a fire condition along a fire alarm line. The possible values of this parameter are 1, 2 and 3 checks.



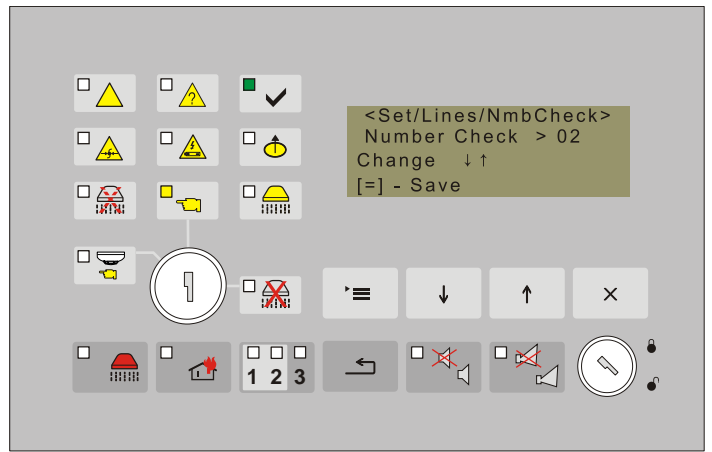

The factory setting is 2 checks.

Use the buttons  and  to change alternatively the parameter, the button  to confirm the new value and the button  to exit.



13.4.3.3. Screen *Check for Removed Fire Detector*

The value of this parameter determines if the fire extinguishing control panel shall monitor the fault condition – removed fire detector. If this function will be used then diode should be installed in the bases of the fire detectors as it is shown in the diagram for connecting the fire detectors. The factory setting is Check ON.

Use the buttons  (Down) and  (Up) to change alternatively the parameter, the button  to confirm the new value and the button  to exit.

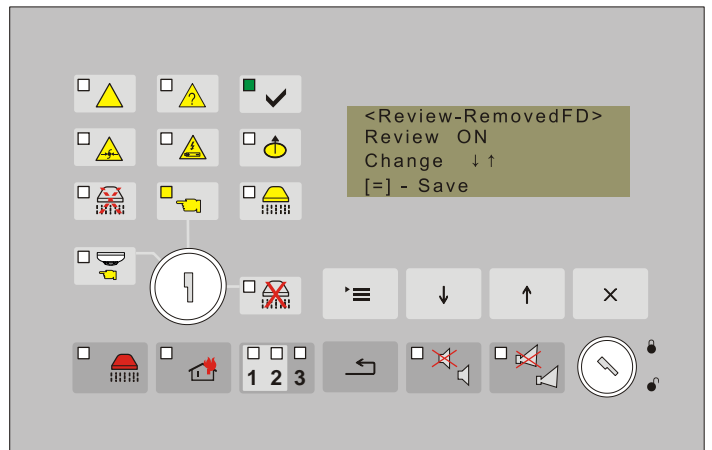





13.4.3.4. Setup Input *Hold*

Due to the specificity of the input Hold, the active status for this function is OPEN contact. it is provided the logic of the contact to be turned in the case of not standard installations as the active level could be with Closed contact.

According to the standard this input should function with active level OPEN contact, otherwise the other option is an exception.

The factory setting is active level with OPEN contact.

Use the buttons  (Down) and  (Up) to change alternatively the parameter, the button  to confirm the new value and the button  to exit.

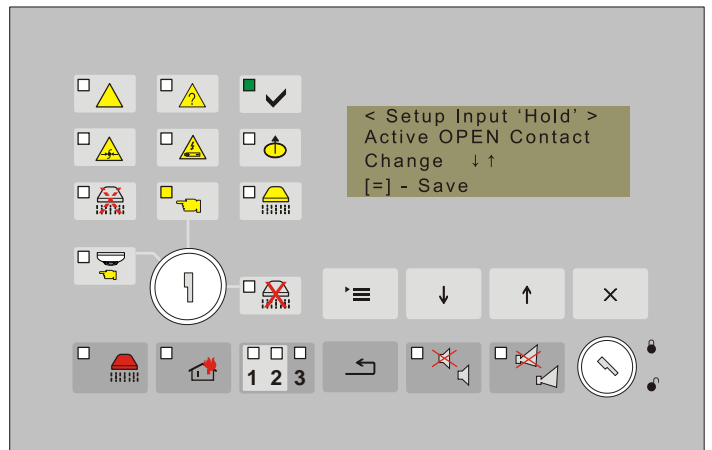







13.4.3.5. Setup Input *Low Press*

Due to the specificity of the input to monitor the leaking of the extinguisher, the active status for this function is OPEN contact. it is provided the logic of the contact to be turned in the case of not standard installations as the active level could be with Closed contact.

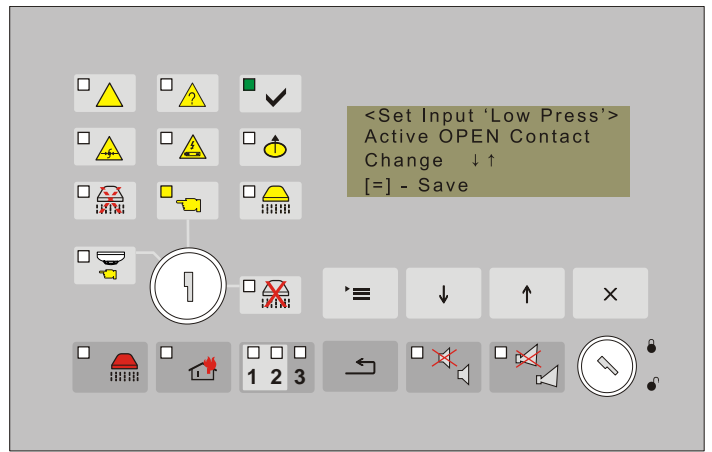
According to the standard this input should function with active level OPEN contact, otherwise the other option is an exception.





The factory setting is active level with OPEN contact.



Use the buttons  (Down) and  (Up) to change alternatively the parameter, the button  to confirm the new value and the button  to exit.

13.4.4. Function *Time Extinguishing*



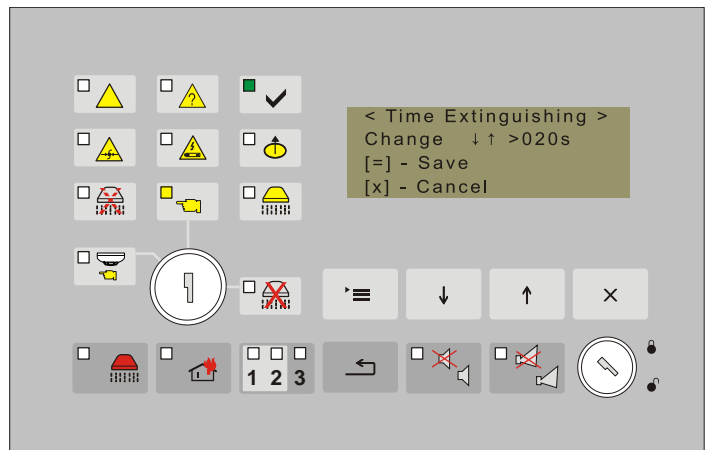

Use this function to set the time for extinguishing. The specific value of the parameter depends on the utilized automatic devices. The factory setting is 10 seconds as the admissible values are within the range from 1 to 255 seconds.

The active buttons are  and  - to reduce/increase the time for extinguishing. To confirm the new value use the button , to exit – press button .



13.4.5. Function *Time Evacuation*

Use this function to set the time for evacuation The factory setting is 120 seconds as the admissible values are within the range from 1 to 255 seconds.

The active buttons are  and  - to reduce/increase the time for evacuation. To confirm the new value use the button , to exit – press button .

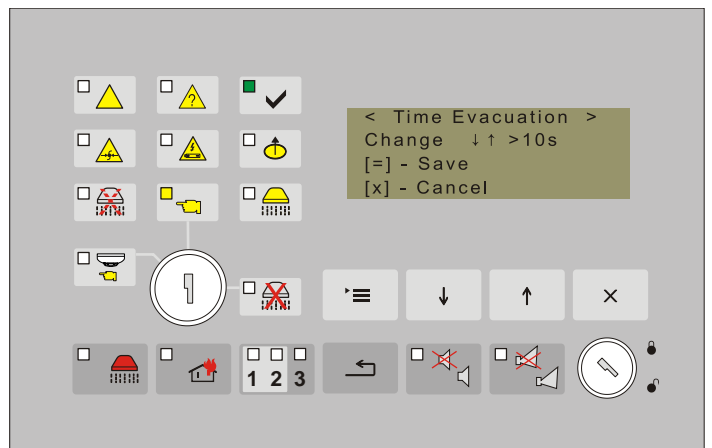

**13.4.6.** The function Factory Settings returns the parameters of the fire extinguishing control panel repeater to their default settings. The specific values of the parameters are given in the previous sections of the instruction manual.

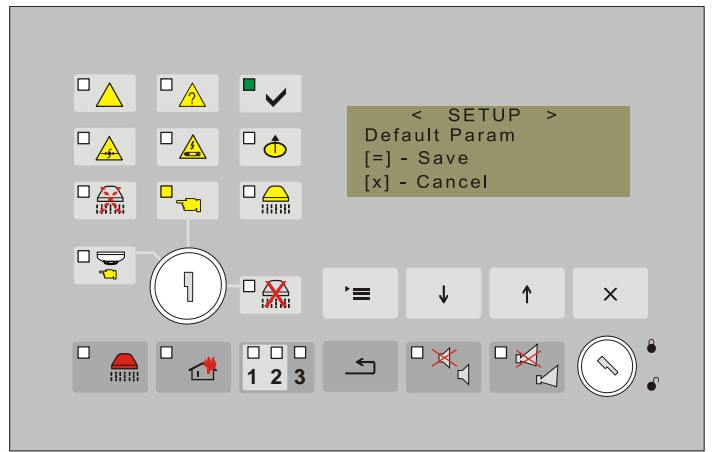

**13.4.7. Function Clear Archive**

This function allows the archive to be cleared from the energy independent memory.

Press the button  to activate the function and to clear the archive.

Important: The fire counter is not cleared. It is reset in a special mode (Access Level 4).

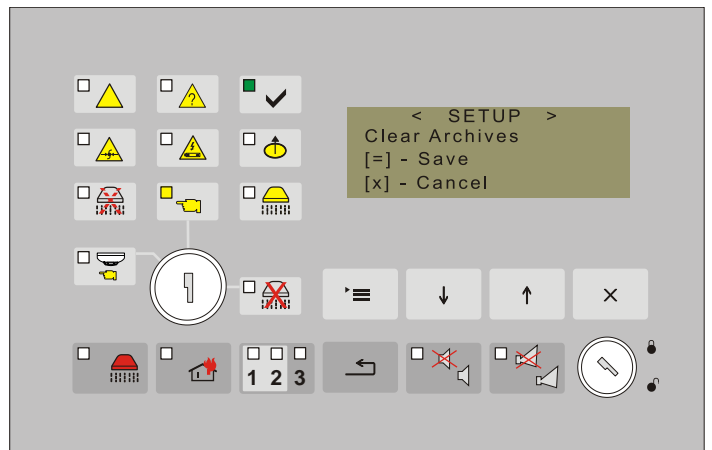

**13.4.8. Function new Password**

This function serves to change the existing password for Access Level 3. The admissible values are from 0000 to 9999.

The factory setting is „0000”.

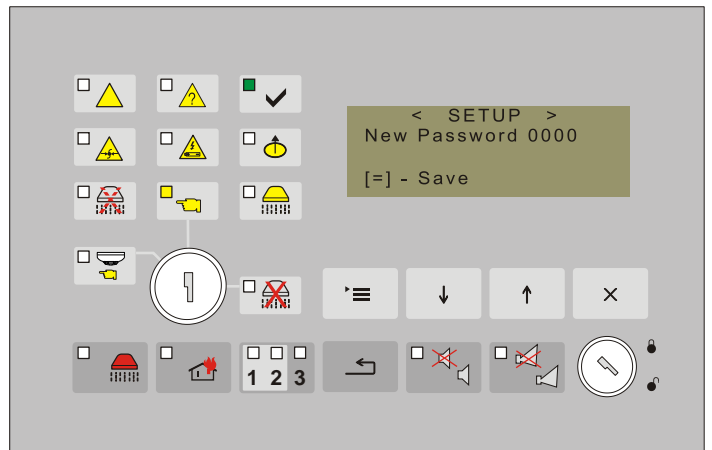

**14. Extinguishing Control Algorithm**

The algorithm to control the outputs and the indication depending on the input influences and the set parameters for the fire extinguishing control panel operation is shown on Drawing 12.

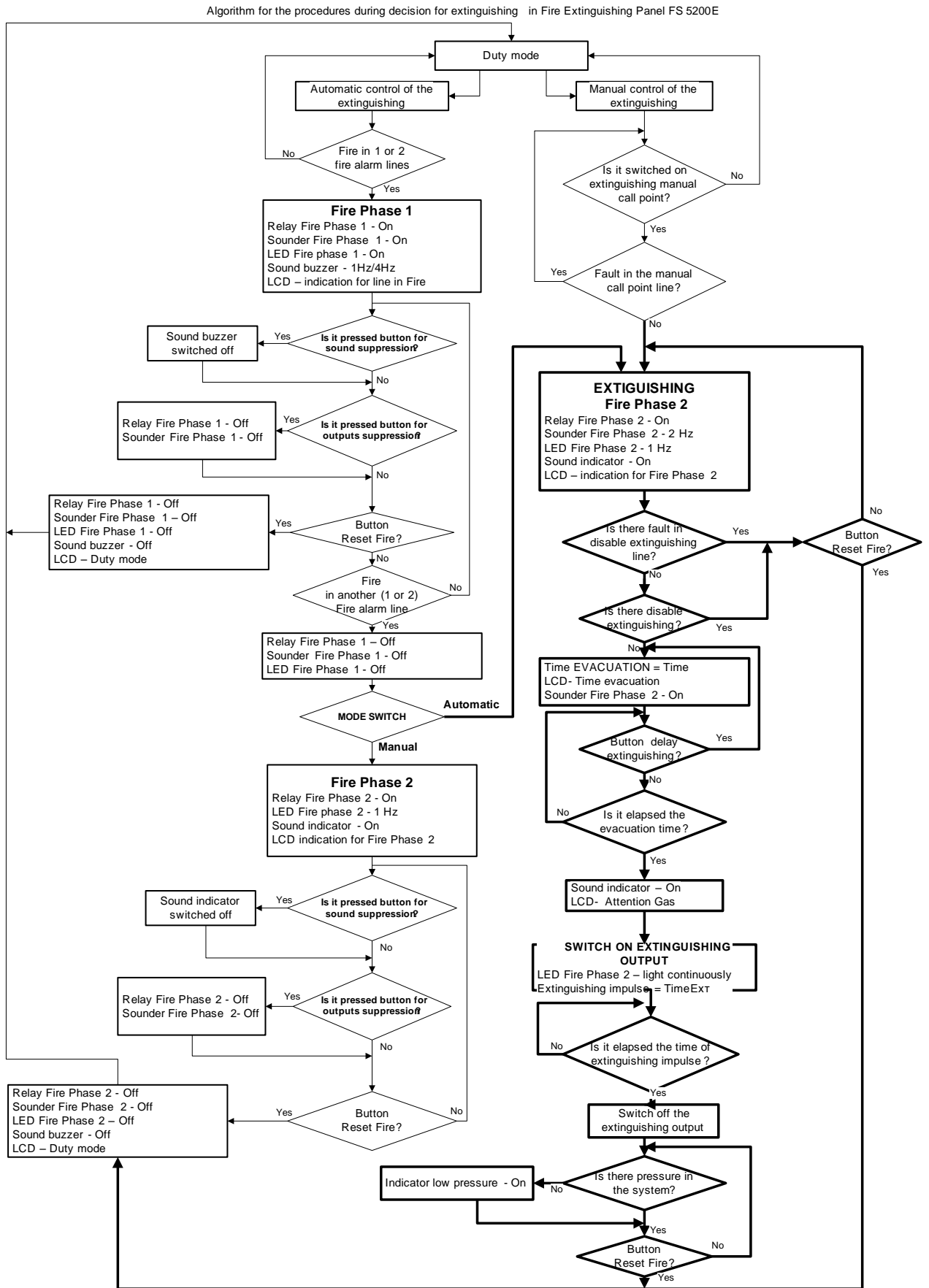

Drawing 12

## 15. Labour protection requirements

The installation and maintenance staff shall be well grounded in equipment's mechanism and operation, as well as in common technical safety regulations.

Connection to unearthed or to indirectly earthing mains supply is prohibited.

Troubleshoots are to be cleared after disconnecting the feeding cable from the mains supply.

The fire extinguishing control panel is designed for installing in premises with a normal fire hazard, as per the Fire Precaution Technical Regulations in Building Construction.

## 16. Fire extinguishing control panel start up

Make sure that the connection to mains power supply is properly made.

Make sure that the periphery devices are correctly connected.

Place the fuse in the terminal with mains fuse, the display illuminates and appears text message with the name of the producer, the initials of the control panel and the software version. Then the display shall show the current time and date.

Connect the feeding cable and the backup batteries; the batteries shall be in a series connection.

Connect the red wire to the positive backup battery pole, and the blue wire – to the negative pole.

The overall voltage of both batteries shall not exceed 17.6V, otherwise the fire extinguishing control panel will not recognize them.

Enter Set Up Mode and configure the common parameters and the lines parameters.

Upon exit of Set Up Mode the fire extinguishing control panel runs all system operations and enters Duty Mode – the control panel is ready to fire protect the site.

## 17. Operation, storage and transportation

### 17.1 Operation and storage

The fire extinguishing control panel shall operate and be kept in closed premises, under the following conditions:

#### 17.1.1. Temperature

- storage - from 5°C to 35°C
- transportation - from minus10°C to 50°C
- operational - from minus 5°C to 40°C

#### 17.1.2. Relative humidity

- storage - to 80%
- operational - to 93%

### 17.2. Transportation

The fire extinguishing control panel shall be transported by vehicles, in factory packing, in the above stated environmental conditions and at sinusoidal vibrations with acceleration amplitude not more than 4,9m/s<sup>2</sup> in frequency range 10 to 150Hz.

## 18. Warranty

The producer guarantees compliance of the device with EN 54-2:1997/ A1:2006/AC: 2009, EN 54-4:1997/A2: 2006/AC: 2009, EN 12094-1: 2003. The warrant period is 24 months from the date of the purchase, providing that

- the conditions of storage and transportation have been observed;
- the startup has been done by authorized personnel only
- the requirements for operation stated herein have been observed.

#### UniPOS

47, "San Stefano" Str., 5800 Pleven, BULGARIA  
 phone +359 64 891111, +359 64 891 100, fax +359 64 891 110  
 e-mail: office\_pleven@unipos-bg.com

Mladost 1, bl.79B, entr.2, ap.17, 1784 Sofia, BULGARIA  
 phone/fax +359 2 9744469, +359 2 9743925  
 e-mail: office\_sofia@unipos-bg.com

www.unipos-bg.com

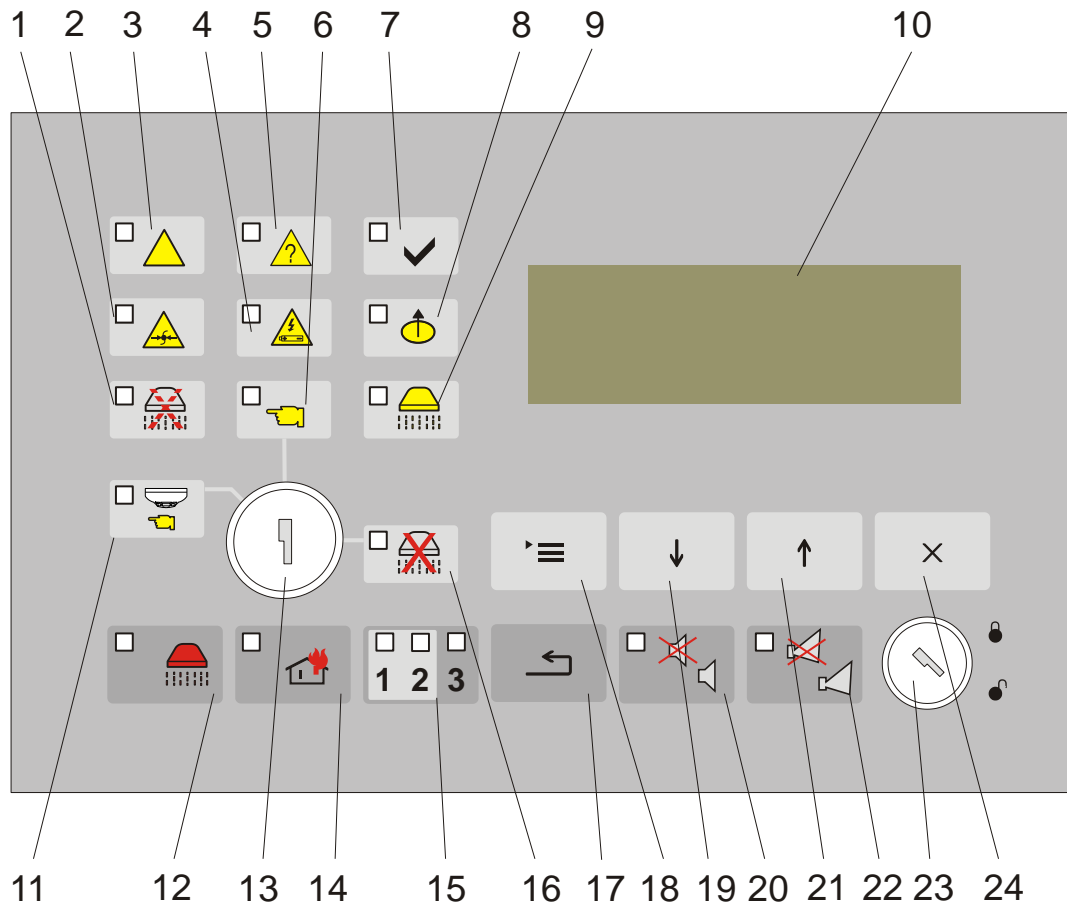
**Appendixes****Appendix 1**

Front panel of fire extinguishing control panel FS5200E

- 1 Indicator *Hold extinguishing*
- 2 Indicator *Fault in a circuit of signal wires*
- 3 Indicator *System Error*
- 4 Indicator *Fault in power supply*
- 5 Common Indicator *Fault Condition*
- 6 Indicator *Manual Mode*
- 7 Indicator *Power Supply*
- 8 Indicator *Disabled Component*
- 9 Indicator *Low Pressure*
- 10 LCD display (4x20)
- 11 Indicator *Automatic Mode*
- 12 Indicator *Fire condition stage II – Extinguishing*
- 13 Switch – *Automatic / Manual / Disable*
- 14 Indicator *Fire condition stage I*
- 15 Individual indicators of the Fire detecting lines
- 16 Indicator *Disable extinguishing*
- 17 Button *Reset*
- 18 Button *Menu*
- 19 Button *Down*
- 20 Button *Alarm* with indicator *Stop alarm*
- 21 Button *Up*
- 22 Button *Outputs* with indicator *Suppressed outputs*
- 23 Switch – *Access level*
- 24 Button *Cancel*

General menu of panel FS5200E

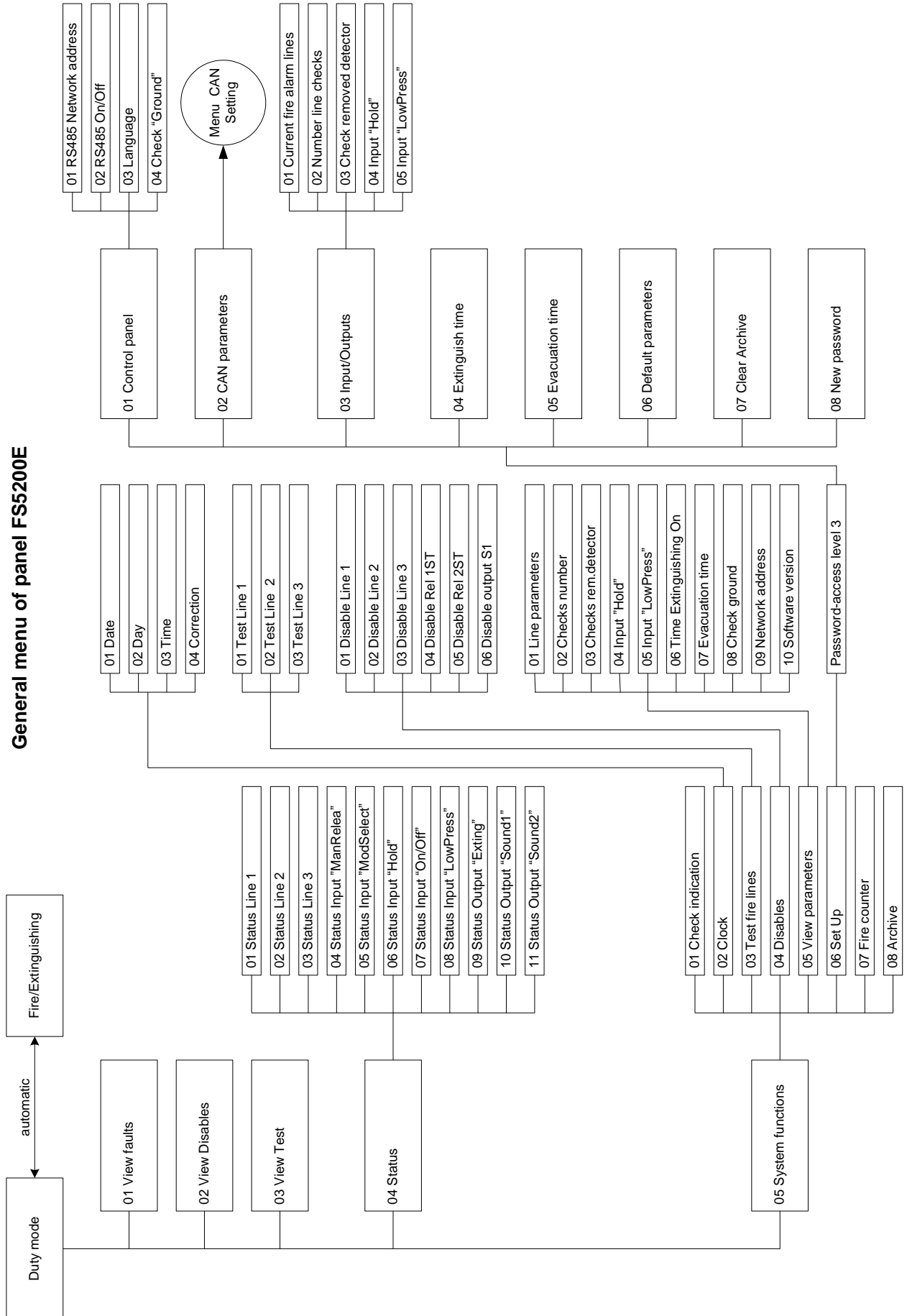

Appendix 3

