

VARIOUS OPTIONS

Anti Bird Cap ABC-4

for all models

Prevents birds and small animals from sitting on the detector. Protects the front of the detector from excessive rain and snow.



Back Cover BC-4

for all models

Conceals the back side of a pole mounted detector.



Pole Side Cover PSC-4

for all models

Conceals the gap between two pole mounted detectors in back to back.

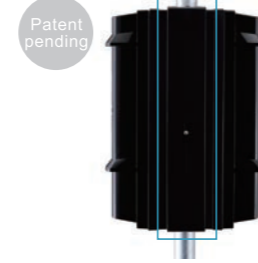

Conduit Bracket CBR-4

for all models



Heating Unit HU-3

for Hard-wired models



Power input	24VAC/DC
Current draw	420mA(max.) (Per 1 unit)
Thermo switch	60°C (140°F)

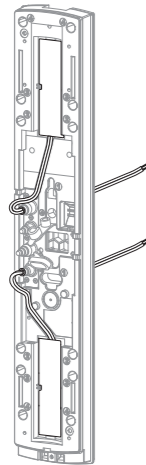

Solar Battery Unit SBU-4

for SL-QDM only

Supplies power by high efficiency solar battery. Li-ion rechargeable battery and Anti-Bird Needles are included.

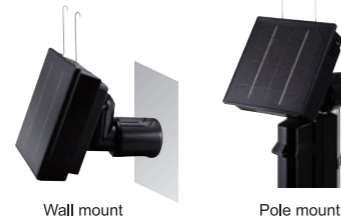

Extension Cable with Connector EC-4

for SL-QFR/QNR only

Extension cables between the back box and the main unit. When installing in a beam tower.

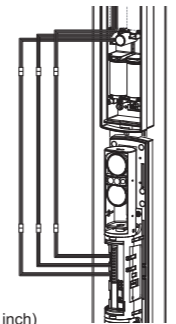

Cable length: 500 mm (19.7 inch)

Battery Common Unit BCU-4

for SL-QFR/QNR AX-TFR only

Shares power source and low battery signals between the main unit and the wireless transmitter.



Input voltage	3.2 - 4.0 VDC	
Current draw	Approx. 5 μA at 3.6 VDC (no load)	
Output voltage	Normal	Approx. 2.3 - 3.6 VDC
	Low battery	Approx. 2.0 - 2.6 VDC
Output current	100 mA (max.)	
Operating temperature	-20°C - +60°C (-40°F - +140°F)	
Operating humidity	95% (max.)	

Beam Alignment Unit BAU-4

for all models

Aligns optical axis automatically. (SL-QDP/QN/QFR/QNR: applicable to receiver only)



SHORT RANGE MODELS



AX-100TFR/200TFR

BATTERY OPERATED PHOTOELECTRIC DETECTOR

AX-100TFR : Detection range 30m / 100ft.
AX-200TFR : Detection range 60m / 200ft.



AX-70TN/130TN/200TN

SHORT RANGE PHOTOELECTRIC DETECTOR

AX-70TN : Detection range 20m / 70ft.
AX-130TN : Detection range 40m / 130ft.
AX-200TN : Detection range 60m / 200ft.

AX-100TF/200TF

4ch. BEAM FREQUENCIES SELECTABLE MODELS

AX-100TF : Detection range 30m / 100ft.
AX-200TF : Detection range 60m / 200ft.



OPTEX CO., LTD. (JAPAN)

URL: <http://www.optex.net/>

OPTEX INC. (U.S.)

URL: <http://www.optexamerica.com/>

OPTEX DO BRASIL LTDA. (Brazil)

URL: <http://www.optex.net/br/es/sec/>

OPTEX (EUROPE) LTD. / EMEA HQ (U.K.)

URL: <http://www.optexeurope.com/>

OPTEX TECHNOLOGIES B.V.

(The Netherlands)

URL: <http://www.optex.nl/>

OPTEX SECURITY SAS (France)

URL: <http://www.optex-security.com/>

OPTEX SECURITY Sp.z o.o. (Poland)

URL: <http://www.optex.com.pl/>

OPTEX PINNACLE INDIA, PVT., LTD. (India)

URL: <http://www.optex.net/in/en/sec/>

OPTEX KOREA CO.,LTD. (Korea)

URL: <http://www.optexkorea.com/>

OPTEX (DONGGUAN) CO.,LTD.

SHANGHAI OFFICE (China)

URL: <http://www.optexchina.com/>



PHOTOELECTRIC DETECTOR

Smart Line™ series

HARD-WIRED MODELS

ADVANCED MODELS

SL-200QDM : 60m / 200ft.

SL-350QDM : 100m / 350ft.

SL-650QDM : 200m / 650ft.

STANDARD MODELS

SL-200QDP : 60m / 200ft.

SL-350QDP : 100m / 350ft.

SL-650QDP : 200m / 650ft.

BASIC MODELS

SL-200QN : 60m / 200ft.

SL-350QN : 100m / 350ft.

SL-650QN : 200m / 650ft.

BATTERY OPERATED MODELS

STANDARD MODEL

SL-350QFR : 100m / 350ft.

BASIC MODEL

SL-350QNR : 100m / 350ft.



Anyone can LOCK ON,

Automatically LOCK ON.



SHUT OUT ANY TROUBLES

The IR transmitter and receiver must be perfectly aligned in order to achieve the optimal operation of the photoelectric detector. However, a great deal of patience, time and effort is required to ensure that the receiver is receiving the maximum amount of infrared signal possible from the transmitter. Optex has the solution the SL series is designed to lighten your workload while achieving perfect alignment.

SNIPER VIEWFINDER™

X2 MAGNIFICATION LENS

The new telescope lens has a high level of visibility for optical alignment work. Even over long distances, a perfect installation and stable performance can be achieved in a short period.



Conventional model



X2 magnification lens

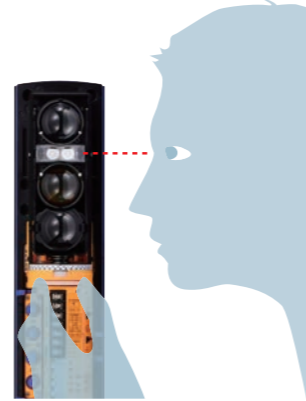

BEAM ALIGNMENT UNIT : BAU-4 (option)

The BAU-4 beam alignment unit automatically and accurately adjusts the optical axis. This allows peak performance and gives one technician the ability to install the 200 m (650 ft.) Smart Line detector by himself.

THE world first
AUTOMATIC
BEAM ALIGNMENT



HORIZONTAL



VERTICAL

LED INDICATOR AND SOUND ASSIST

SL-QDM: TRANSMITTER AND RECEIVER
SL-QDP: RECEIVER only

The alignment level indicators have 5 LEDs, each LED represents the level of alignment, ranging from poor to excellent. The optical alignment level can also be checked by sound.



TRANSMITTER



RECEIVER

UPPER/LOWER BEAM SELECTION BUTTON

SL-QDM/SL-QDP only: TRANSMITTER AND RECEIVER

Optical alignment can be done without using a beam blocking plate since the SL has upper/lower beam selection button which enables to turn on and off the upper and lower beam alternately in the installation mode.



Double Modulation Beam (SL-QDM/QDP only)

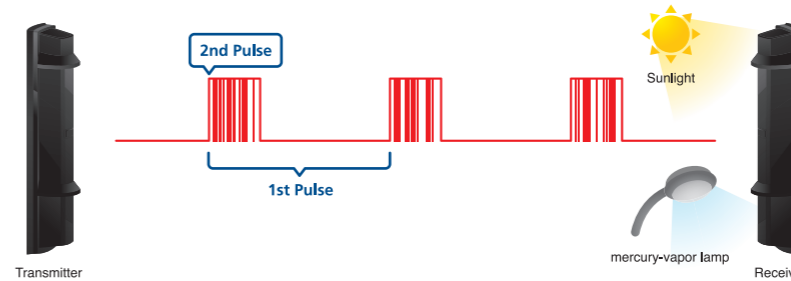

The SL-QDM and SL-QDP series offer double modulation beams that differ in pulse patterns. This can enhance signal discrimination against potential noise interference such as sunlight or other external light sources, resulting in a reduction of missed or false alarms. Together with OPTEX triple layered Sunshine Protection Technology, it ensures high reliability under the severe outdoor security environment.

QUAD BEAM & UNITED APPEARANCE

By employing quad beam, it dramatically reduces false alarm caused by birds and falling leaves. Moreover, it is also important that the housing design of both long and short beams is harmonised. 60m (200ft.) range models, SL-200QN/SL-200QDP/SL-200QDM with a wide beam pitch is now available.



Conventional short beam



Smartline series

IP65 WATER/DUST PROTECTION

Rubber seals is used for all conceivable points where water or dust may penetrate, such as wiring holes, wire ports and the outer openings on chassis.



UV-resistant POLY CARBONATE COVER

Front cover is not clouded by ultraviolet ray during a long term. Therefore it will maintain the transparency of IR beams.



CONVENTIONAL

SL series

SLIM BODY & LIGHT WEIGHT

20% reduction of the body size and 15% reduction of the weight come together in the SL series.

BEAM BLOCKING PLATE

The plate can firmly be fixed on the lens unit without fear of being blown off by wind. The plates can be stored in the back of the front cover.

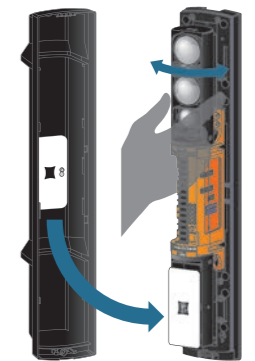

ANTI FROST DESIGN (Hood design)

The hoods are positioned on both the upper beam and the lower beam to secure a high and stable beam power by preventing frost from attaching to the front cover.

VIVID INTERIOR COLOR

Easy-to-see vivid interior color for optical alignment.

ALIGNMENT DIAL

The alignment no longer requires a screwdriver. All you need is touch with your fingers for precise adjustment.

QUAD BEAM WITH ASPHERICAL LENSES

The high-grade aspherical lens create more sharply defined and precise active infrared beams.

ENVIRONMENT RESISTANCE

SUNSHINE PROTECTION TECHNOLOGY (SL-QDM/SL-QDP only)

The sunshine protection technology has a triple layer construction to give better performance against external light sources (e.g.:The sun, mercury-vapour lamps, and fluorescent lights).

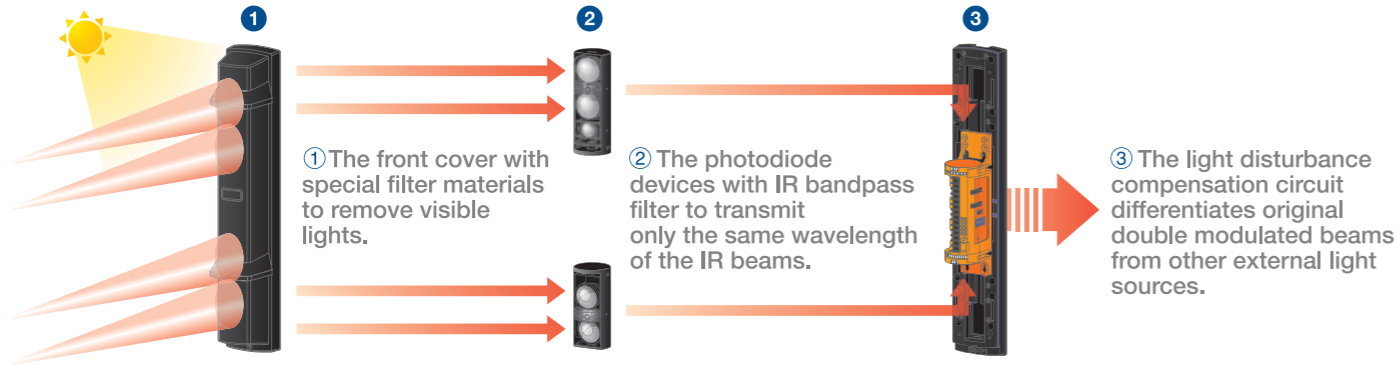

BEAM POWER CONTROL SELECTOR (SL-QDM/SL-QDP only)

The beam power control selector allows you to manually adjust beam power from NORMAL to LOW or VERY LOW. This function is effective for the following purposes:

- For countermeasure against crosstalk due to reflection of wall or floor by reducing beam power.
- For countermeasure against interference due to unstable S/N (signal / noise) ratio when using multiple photo beams for long distance or beam stacking applications.
- To reduce beam power when using the detector for a distance shorter than the rated distance.
- To search the peak value when making optical alignment to support perfect alignment.

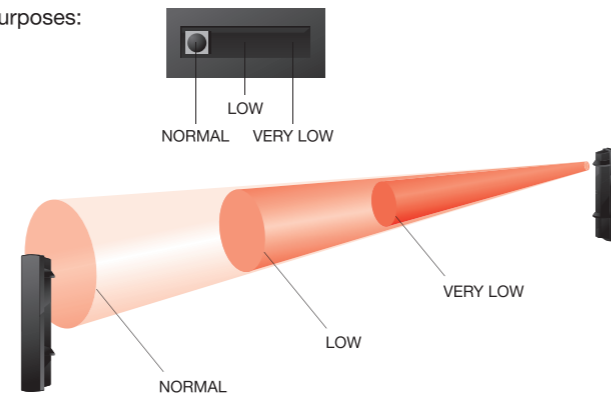

A.T.P.C.-AUTOMATIC TRANSMIT POWER CONTROL (SL-QDM only) Patent pending

Automatically controls, adjusts and optimizes the power of the beam and maintains optimal performance. It decreases false and missed alarms caused by fog, frost, cross talk, and signal saturation.

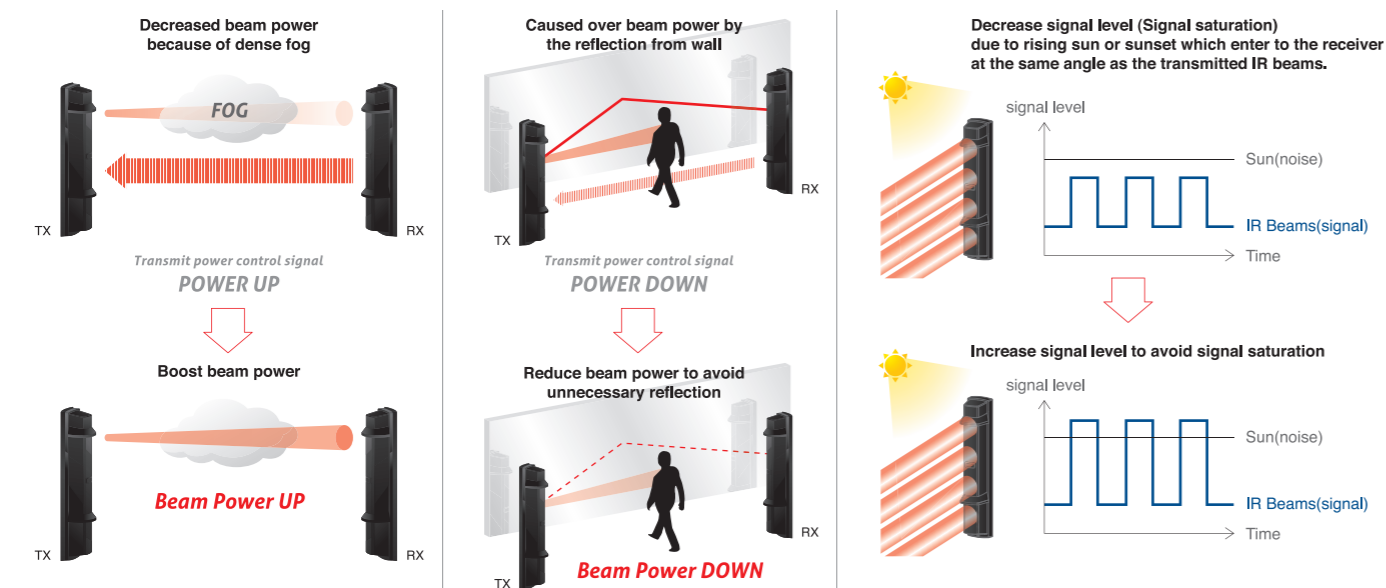

SELECTION GUIDE

	HARD-WIRED MODELS			BATTERY OPERATED MODELS		
	ADVANCED	STANDARD	BASIC	STANDARD	BASIC	SOLAR BATTERY
	SL-200QDM SL-350QDM SL-650QDM 	SL-200QDP SL-350QDP SL-650QDP 	SL-200QN SL-350QN SL-650QN 	SL-350QFR 	SL-350QNR 	SBU-4+ SL-QDM series
++ Most appropriate + Appropriate						
LIGHT DISTURBANCE (Expected impact :False alarm)	++	+				++
REFLECTION (Expected impact :Missed alarm)	++	+				++
INTERFERENCE (Expected impact :Missed alarm)	++	+		+		++
FOG (Expected impact :False alarm)	+					+
LIGHTNING (Expected impact :Unit damage)	+	+	+	++	++	++
FROST (Expected impact :False alarm)	++	+	+			
RE-TRANSMISSION FUNCTION 	+					+
LED INDICATOR AND SOUND ASSIST 	++	+				++
WIRELESS (BATTERY OPERATED) 				++	++	+

HARD-WIRED MODELS

ADVANCED MODEL

SL-200QDM/350QDM/650QDM

FEATURES

- High power quad beam
- Double modulation
- Beam power control selector
- A.T.P.C.-Automatic transmit power control
- I.A.S.C.-Integrated alignment status communication
- Upper/lower beam selection button
- Beam power control selector
- Solar battery unit (Option : SBU-4)

Specifications

Model	SL-200QDM	SL-350QDM	SL-650QDM
Detection range	60m/200ft.	100m/350ft.	200m/650ft.
Beam frequencies	4ch selectable		
Current consumption	Normal 26mA/Max. 60mA		
Ambient temperature	-35°C - +60°C (-30°F - 140°F)		
Water protection	IP65		
Dimensions H x W x D	448 (17.6) x 79 (3.1) x 96 (3.8) mm(inch)		
Weight	2500 g(88.2oz)		

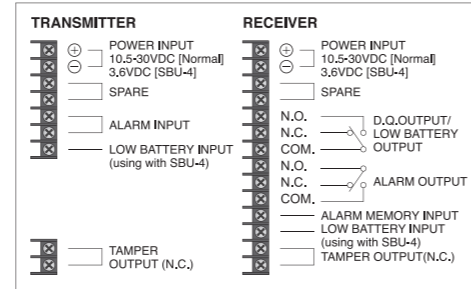

NO WIRING for POWER,
NO WIRING for SIGNAL.



STANDARD MODEL

SL-350QFR

FEATURES

- Long distance 100m / 350ft.
- Long battery life - 4 to 8 years
- Spacious back box for wireless transmitter

BASIC MODEL

SL-350QNR

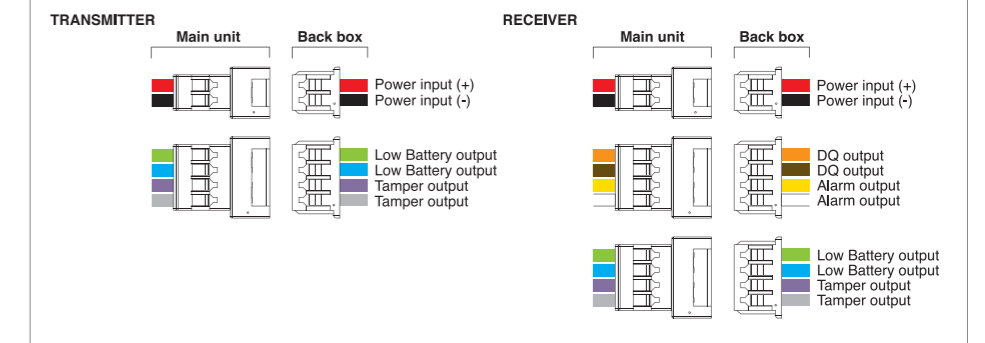

Specifications

Model	SL350QFR	SL-350QNR
Detection range	100m/350ft.	100m/350ft.
Beam frequencies	4ch selectable	
Power source	Recommend: 3.6 V, 13.0Ah LSH20 lithium batteries manufactured by SAFT Operating range: 3.2 V - 4.0 V lithium batteries Transmitter: 2 or 4 units, Receiver: 2 or 4 units	
Current consumption	745µA	
Operating temperature	-20°C - +60°C (-4°F - 140°F)	
Water protection	IP65	
Dimensions H x W x D	452 (17.9) x 83 (3.3) x 138 (5.4) mm(inch)	
Weight	3300 g	

STANDARD MODEL

SL-200QDP/350QDP/650QDP

FEATURES

- High power quad beam
- Double modulation
- Upper/lower beam selection button
- Beam power control selector

Specifications

Model	SL-200QDP	SL-350QDP	SL-650QDP
Detection range	60m/200ft.	100m/350ft.	200m/650ft.
Beam frequencies	4ch selectable		
Current consumption	Normal 17mA/Max. 24mA		
Ambient temperature	-35°C - +60°C (-30°F - 140°F)		
Water protection	IP65		
Dimensions H x W x D	448 (17.6) x 79 (3.1) x 96 (3.8) mm(inch)		
Weight	2400g(84.6oz)		

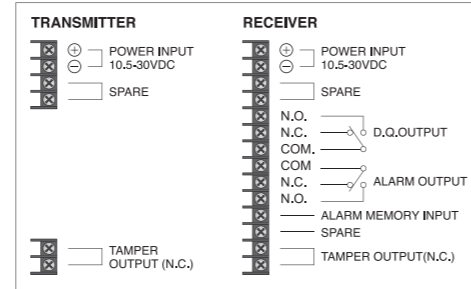

OPTION

LONG DISTANCE 200m,
WIRELESS READY.



* The detector is sold separately.

Replacement battery
Rechargeable Li-ion Battery Pack

LB-4
Approx. 2900 mAh



SOLAR BATTERY UNIT (OPTION)

SBU-4

for SL-200QDM/SL-350QDM/SL-650QDM only



FEATURES

- Small size and light weight Li-ion battery pack
- Long battery life - Non-sunshine days : approx. 7 days
- Spacious back box for wireless transmitter
- Battery common use unit (BCU-4 option)
- Anti-bird needle Included

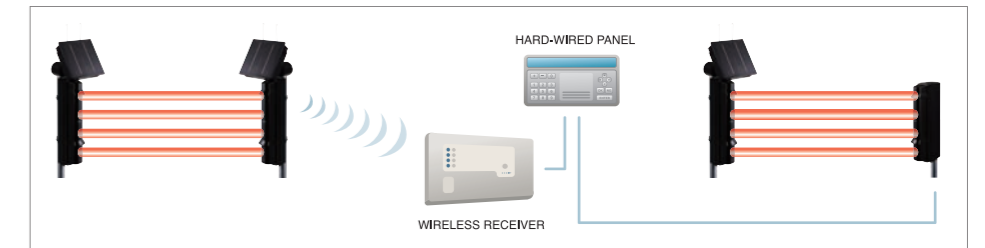
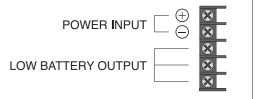

Specifications

Model	SBU-4
Recharging time	Approx. 1 hour on sunshine day Approx. 6 hours on cloudy day
Charging battery protection circuit	Charging is suspended at approx. -5°C or less, or approx. 60°C or more.
Low battery output	Form C relay: 28 VDC, 0.2 A Low battery detection voltage: 3.4 V
Alignment angle	Horizontal : ±180° (30-degree pitch) Vertical : +15° - +90° (5° pitch) Under eave mounting: +0° - +55° (5° pitch)
Mounting	Wall /horizontal surface/pole



BASIC MODEL

SL-200QN/350QN/650QN

FEATURES

- High power quad beam
- Smart design - Slim body
- Vivid interior color

Specifications

Model	SL-200QN	SL-350QN	SL-650QN
Detection range	60m/200ft.	100m/350ft.	200m/650ft.
Beam frequencies	-		
Current consumption	38-40mA		
Operating temperature	-25°C - +60°C (-13°F - 140°F)		
Water protection	IP65		
Dimensions H x W x D	448 (17.6) x 79 (3.1) x 96 (3.8) mm(inch)		
Weight	2400g(84.6oz)		

