



Key Features

- 5 MP high performance COMS
- 2560 × 1944 resolution
- 2.7 mm to 13.5 mm motorized vari-focal lens
- EXIR 2.0, smart IR, up to 40 m IR distance
- OSD menu, 2D DNR, DWDR
- 4 in 1 video output (switchable TVI/AHD/CVI/CVBS)
- IP67, IK10
- Up the coax (HIKVISION-C)



Specification

| Camera | |
|-----------------------------------|---|
| Image Sensor | 5 MP CMOS image sensor |
| Resolution | 2560 (H) × 1944 (V) |
| Min. Illumination | Color: 0.01 Lux @ (F1.2, AGC ON), 0 Lux with IR |
| Shutter Time | PAL: 1/25 s to 1/50, 000 s NTSC: 1/30 s to 1/50, 000 s |
| Lens | 2.7 mm to 13.5 mm motorized vari-focal lens |
| Horizontal Field of View | 95.7° to 29.1° |
| Lens Mount | Φ 14 |
| Day & Night | IR cut filter |
| Angle Adjustment | Pan: 0° to 355°; Tilt: 0° to 75°; Rotate: 0° to 355° |
| Synchronization | Internal synchronization |
| Frame Rate | PAL: 5 MP@20fps, 4 MP@25fps, 1080p@25fps NTSC: 5 MP@20fps, 4 MP@30fps, 1080p@30fps |
| Menu | |
| AGC | Support |
| D/N Mode | Auto/Color/BW (Black and White) |
| White Balance | ATW/MWB |
| BLC | Support |
| DWDR (Digital Wide Dynamic Range) | Support |
| Functions | Brightness, Sharpness, DNR, Mirror, Smart IR |
| Interface | |
| Video Output | 1 HD analog output |
| Switch Button | TVI/AHD/CVI/CVBS |
| General | |
| Operating Conditions | -40 °C to 60 °C (-40 °F to 140 °F), humidity: 90% or less (non-condensation) |
| Power Supply | 12 VDC ±15%, 24 VAC ±15% |
| Power Consumption | DS-2CE5AH0T-VPIT3Z: Max. 4.4 W DS-2CE5AH0T-AVPIT3Z: Max. 6.0 W |
| Protection Level | IP67, IK10 |
| Material | Metal |
| IR Range | Up to 40 m |
| Communication | Up the coax, Protocol: HIKVISION-C (TVI output) |
| Dimensions | ∅ 145 mm × 111.3 mm (∅ 5.70" × 4.37") |
| Weight | DS-2CE5AH0T-VPIT3ZF: Approx. 815 g (1.80 lb.) DS-2CE5AH0T-AVPIT3ZF: Approx. 860 g (1.90 lb.) |

Order Model

DS-2CE5AH0T-VPIT3ZF, DS-2CE5AH0T-AVPIT3ZF

Dimension

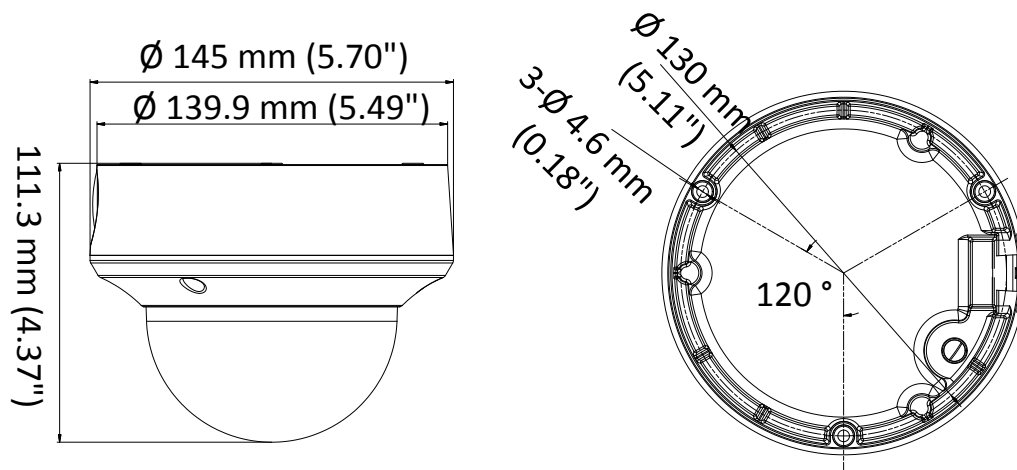

Accessory

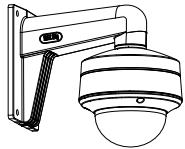

DS-1273ZJ-140-DM45
Wall Mount

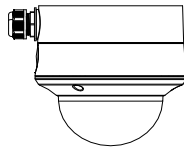
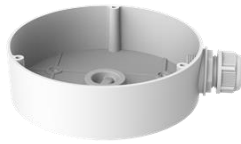

DS-1280ZJ-DM45
Junction Box

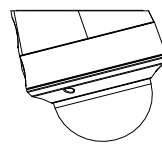
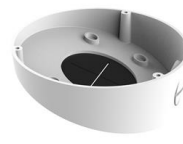

DS-1281ZJ-DM45
Inclined Ceiling Mount

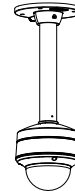

DS-1271ZJ-140-DM45
Pendant Mount

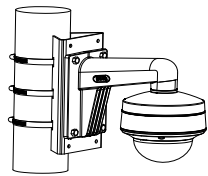

DS-1275ZJ-SUS
Vertical Pole Mount

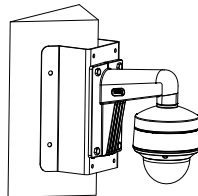

DS-1276ZJ-SUS
Corner Mount

Distributed by



HIKVISION

Headquarters

No.555 Qianmo Road, Binjiang District,
Hangzhou 310051, China
T +86-571-8807-5998
overseasbusiness@hikvision.com

Hikvision USA
T +1-909-895-0400
sales.usa@hikvision.com

Hikvision Italy
T +39-0438-6902
info.it@hikvision.com

Hikvision Singapore
T +65-6684-4718
sg@hikvision.com

Hikvision Africa
T +27 (10) 0351172
sale.africa@hikvision.com

Hikvision Europe
T +31-23-55-42-770
info.eu@hikvision.com

Hikvision France
T +33(0)1-85-330-450
info.fr@hikvision.com

Hikvision Oceania
T +61-2-8599-4233
salesau@hikvision.com

Hikvision Hong Kong
T +852-2151-1761

Hikvision Middle East
T +971-4-8816086
salesme@hikvision.com

Hikvision Spain
T +34-91-737-16-55
info.es@hikvision.com

Hikvision Canada
T +1-909-895-0400
sales.usa@hikvision.com

Hikvision Russia
T +7-495-669-67-99
saleru@hikvision.com

Hikvision Poland
T +48-22-460-01-50
poland@hikvision.com

Hikvision Korea
T +82-31-731-8841
sales.korea@hikvision.com

Hikvision India
T +91-22-28469900
sales@pramahikvision.com

Hikvision UK
T +01628-902140
support.uk@hikvision.com

Hikvision Brazil
T +55 11 3318-0050
Latam.support@hikvision.com