



## Key Features

- 8.29 MP high performance CMOS
- 3840 × 2160 resolution
- 2.8 mm, 3.6 mm, 6 mm fixed lens
- EXIR 2.0, smart IR, up to 30 m IR distance
- 4 in 1 video output (switchable TVI/AHD/CVI/CVBS)
- IP67, IK10
- Up the coax (HIKVISION-C)



## Specification

<b>Camera</b>	
Image Sensor	8.29 megapixel progressive scan CMOS
Signal System	PAL/NTSC
Frame Rate	TVI: 8MP@12.5fps, 8MP@15fps, 5MP@20fps, 4MP@25fps, 4MP@30fps, 2MP@25fps, 2MP@30fps CVI: 8MP@12.5fps, 8MP@15fps AHD: 8M@12.5fps, 8M@15fps CVBS: 960H P/N
Resolution	3840 (H) × 2160 (V)
Min. Illumination	Color: 0.01 Lux@(F1.2, AGC ON), 0 Lux with IR
Shutter Time	PAL: 1/12.5 s to 1/50,000 s NTSC: 1/15 s to 1/50,000 s
Lens	2.8 mm, 3.6 mm, 6 mm fixed lens
Horizontal Field of View	102.2° (2.8 mm), 79° (3.6 mm), 50.8° (6 mm)
Lens Mount	M16
Day & Night	IR cut filter
Angle Adjustment (Bracket)	Pan: 0° to 355°, Tilt: 0° to 75°, Rotate: 0° to 355°
Synchronization	Internal synchronization
DWDR (Digital Wide Dynamic Range)	105 dB
<b>Menu</b>	
AGC	Yes
Day/Night Mode	Auto/Color/BW (Black and White)
White Balance	Auto/Manual
BLC (Backlight Compensation)	Yes
Language	English
Functions	Brightness, Sharpness, DNR, Mirror, Smart IR, HLC
<b>Interface</b>	
Video Output	1 HD analog output
Switch Button	TVI/AHD/CVI/CVBS
<b>General</b>	
Operating Conditions	-40 °C to 60 °C (-40 °F to 140 °F), humidity: 90% or less (non-condensation)
Power Supply	12 VDC ±25% <i>*You are recommended to use one power adapter to supply the power for one camera.</i>
Power Consumption	Max. 5.3 W
Protection Level	IP67, IK10
Material	Metal
IR Range	Up to 30 m
Communication	Up the coax, Protocol: HIKVISION-C (TVI output)
Dimensions	∅ 111 mm × 82.4 mm (∅ 4.4" × 3.2" )
Weight	Approx. 495 g (1.09 lb.)

**Order Model**

DS-2CE57U1T-VPITF

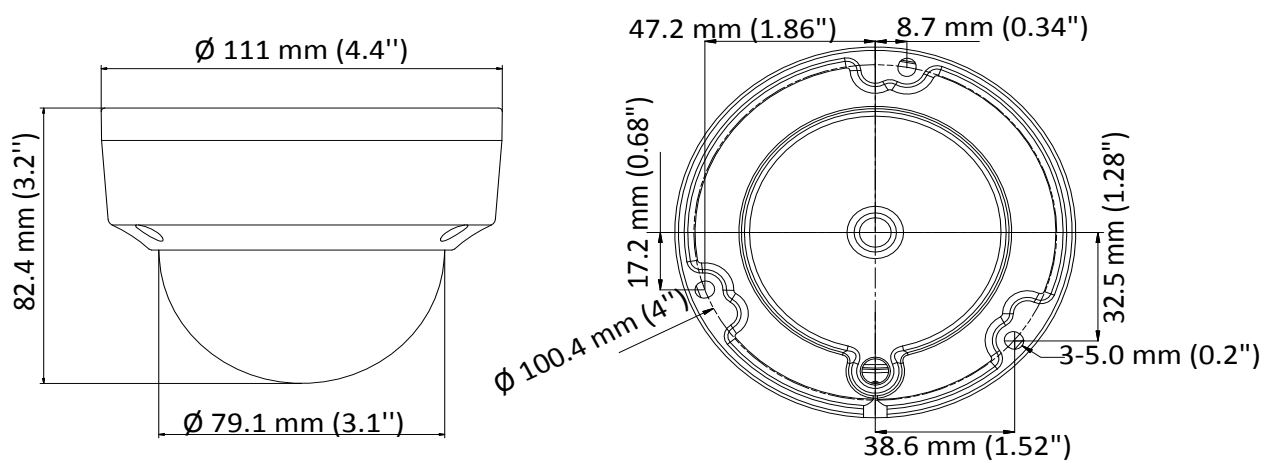
**Dimension**

**Accessory**



**DS-1259ZJ**  
Inclined Ceiling Mount

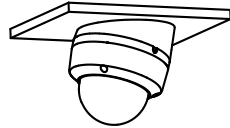

**DS-1271ZJ-110**  
Pendant Mount

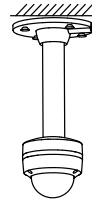

**DS-1272ZJ-110B**  
Wall Mount

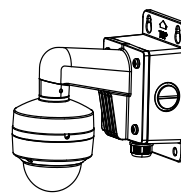

**DS-1272ZJ-110**  
Wall Mount



**DS-1280ZJ-DM18**  
Junction Box

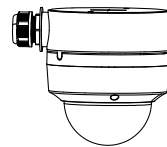

**DS-1258ZJ**  
Wall Mount

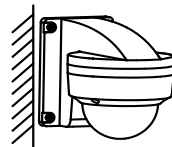

**DS-1275ZJ-SUS**  
Vertical Pole Mount

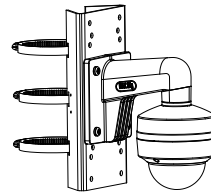

Distributed by



**HIKVISION**

**Headquarters**

No.555 Qianmo Road, Binjiang District,  
Hangzhou 310051, China  
T +86-571-8807-5998  
overseasbusiness@hikvision.com

**Hikvision USA**  
T +1-909-895-0400  
sales.usa@hikvision.com

**Hikvision Europe**  
T +31-23-55-42-770  
info.eu@hikvision.com

**Hikvision Middle East**  
T +971-4-8816086  
salesme@hikvision.com

**Hikvision Russia**  
T +7-495-669-67-99  
saleru@hikvision.com

**Hikvision India**  
T +91-22-28469900  
sales@pramahikvision.com

**Hikvision Italy**  
T +39-0438-6902  
info.it@hikvision.com

**Hikvision France**  
T +33(0)1-85-330-450  
info.fr@hikvision.com

**Hikvision Spain**  
T +34-91-737-16-55  
info.es@hikvision.com

**Hikvision Poland**  
T +48-22-460-01-50  
poland@hikvision.com

**Hikvision UK**  
T +01628-902140  
support.uk@hikvision.com

**Hikvision Singapore**  
T +65-6684-4718  
sg@hikvision.com

**Hikvision Oceania**  
T +61-2-8599-4233  
salesau@hikvision.com

**Hikvision Canada**  
T +1-909-895-0400  
sales.usa@hikvision.com

**Hikvision Korea**  
T +82-31-731-8841  
sales.korea@hikvision.com

**Hikvision Brazil**  
T +55 11 3318-0050  
Latam.support@hikvision.com

**Hikvision Africa**  
T +27 (0) 0351172  
sale.africa@hikvision.com

**Hikvision Hong Kong**  
T +852-2151-1761