

TriWatcher SIR10

Intelligent Outdoor Detector



Atsumi Electric Co.,Ltd.

New Unique Idea 3 PIR Detection

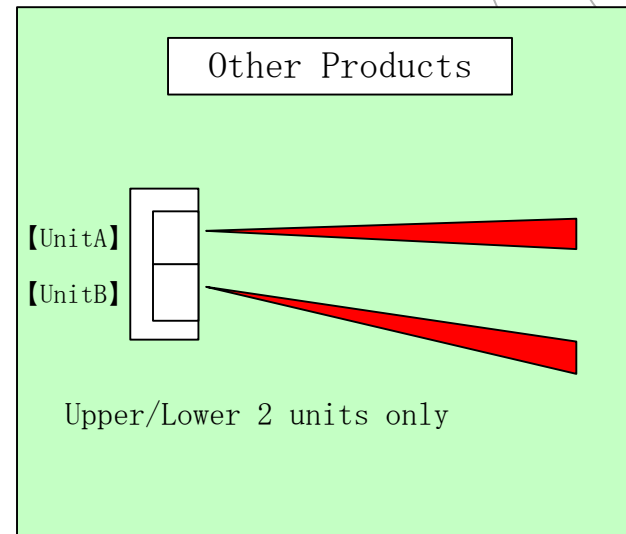
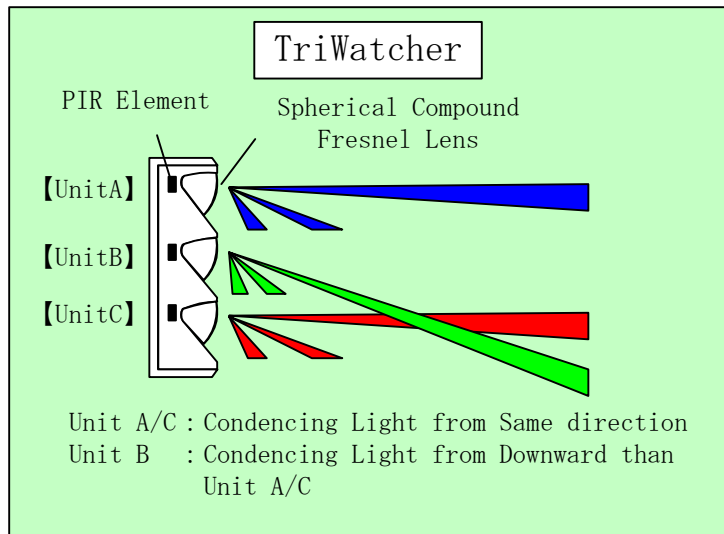

3 Independent Detection Units

- Detection Zones of Each 3 Detection Unit are allocated Ideally (Detection Zones are not simply subdivided but Each Zone has each purpose.)
- Information from 3 units are processed by CPU and Intruder and others are discriminated.

Detection Area

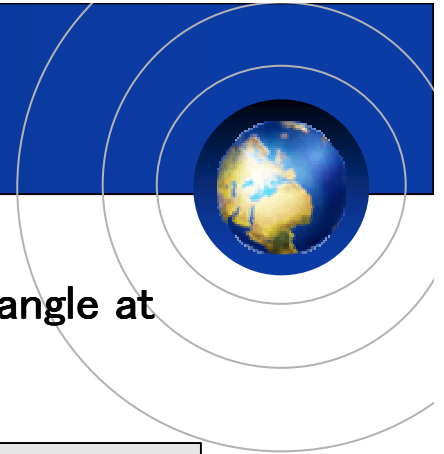

Top view

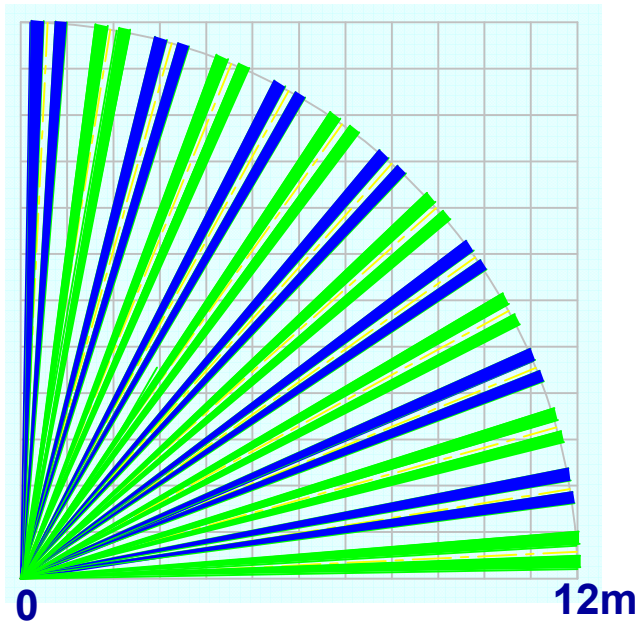

Side view

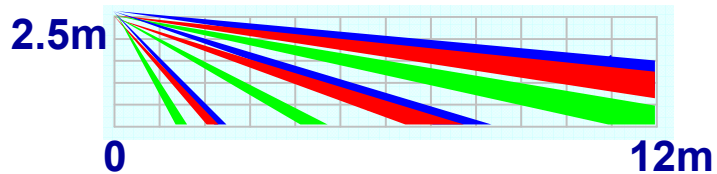

Detection area of Wide angle at 2.5m height

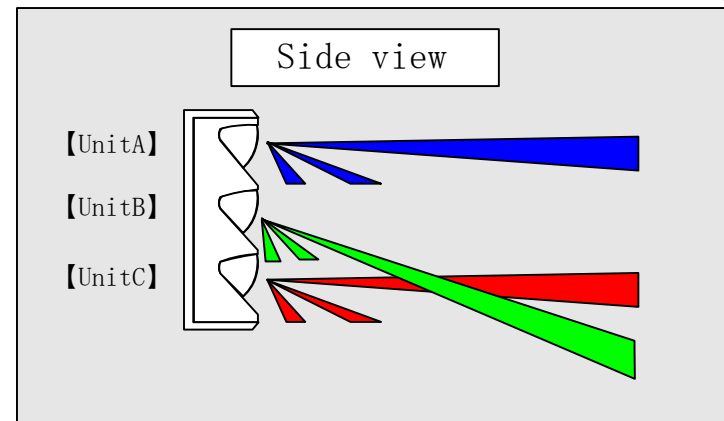

- Blue : Zone of Unit A
- Green : Zone of Unit B
- Red : Zone of Unit C

Detection Zone Structure

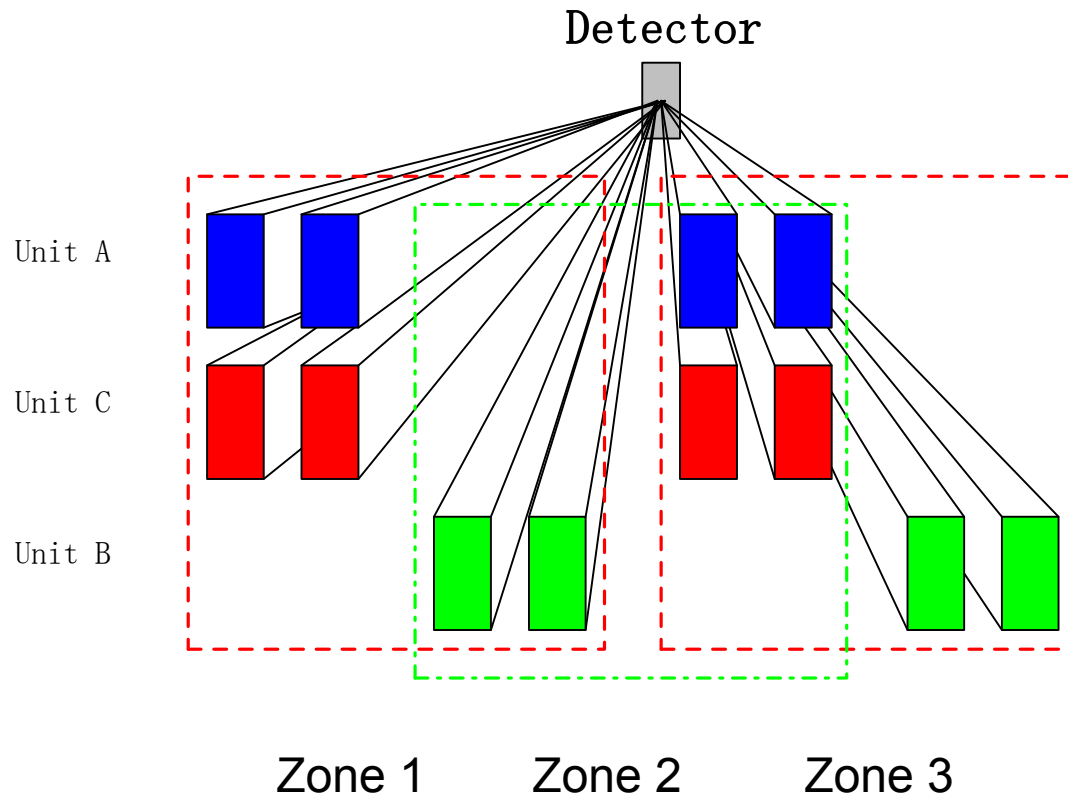
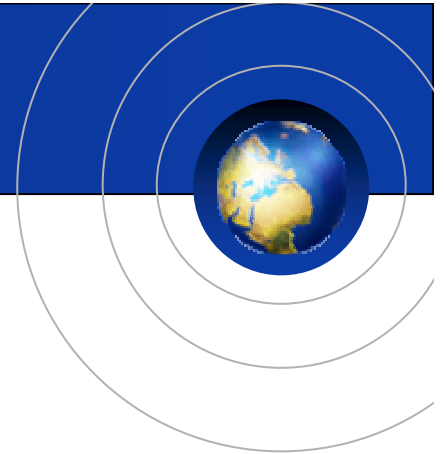

Newly Developed Features



“TriWatcher” Method overcome False Alarm

Sun light

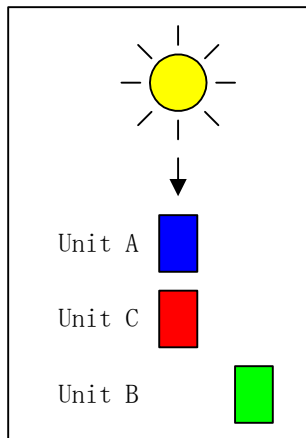

Swaying tree

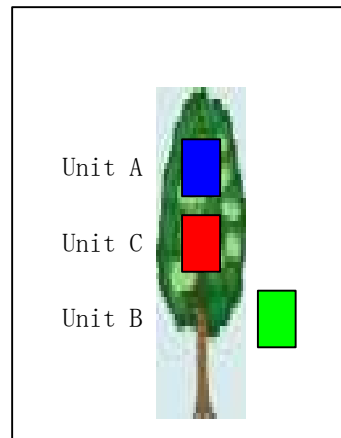

**Bug/bird/
Fallen leaves**

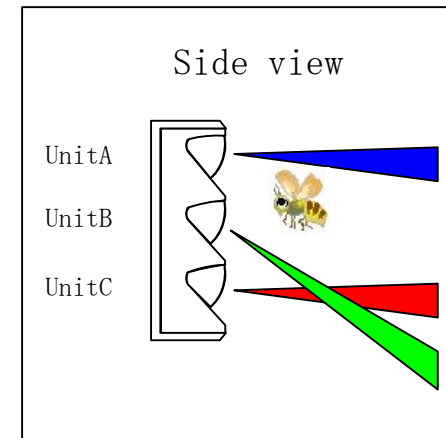

NO False Alarm = Stable system

White Light Reflection

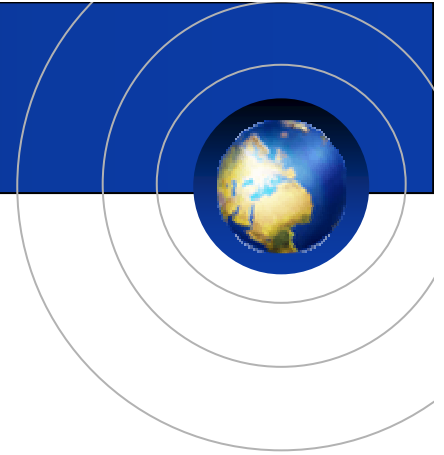

Usual Detector

Detector

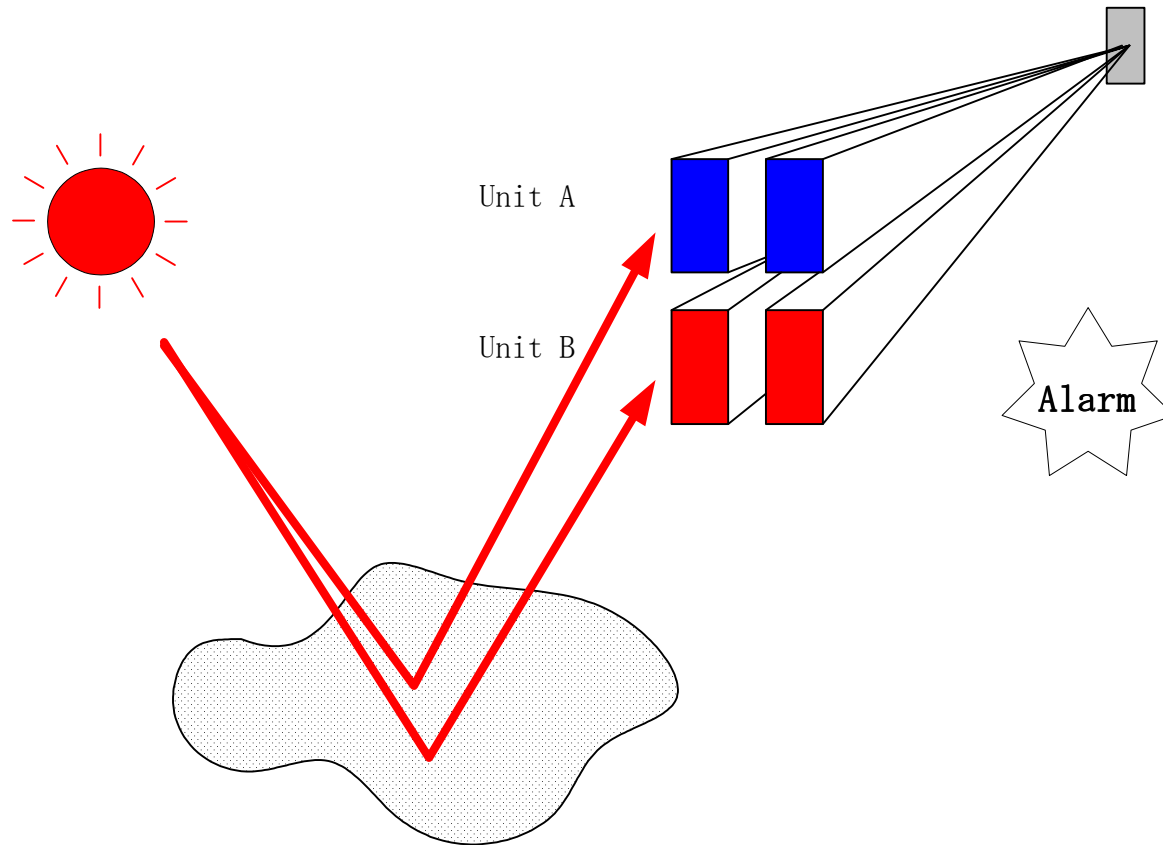

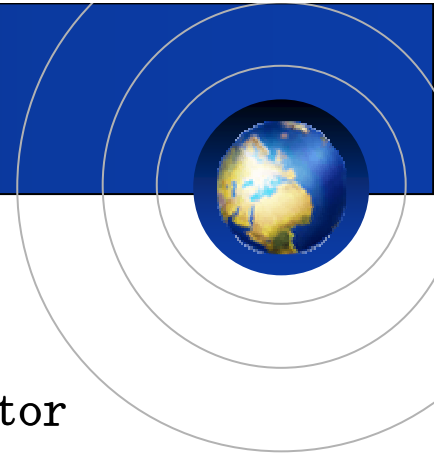

TriWatcher

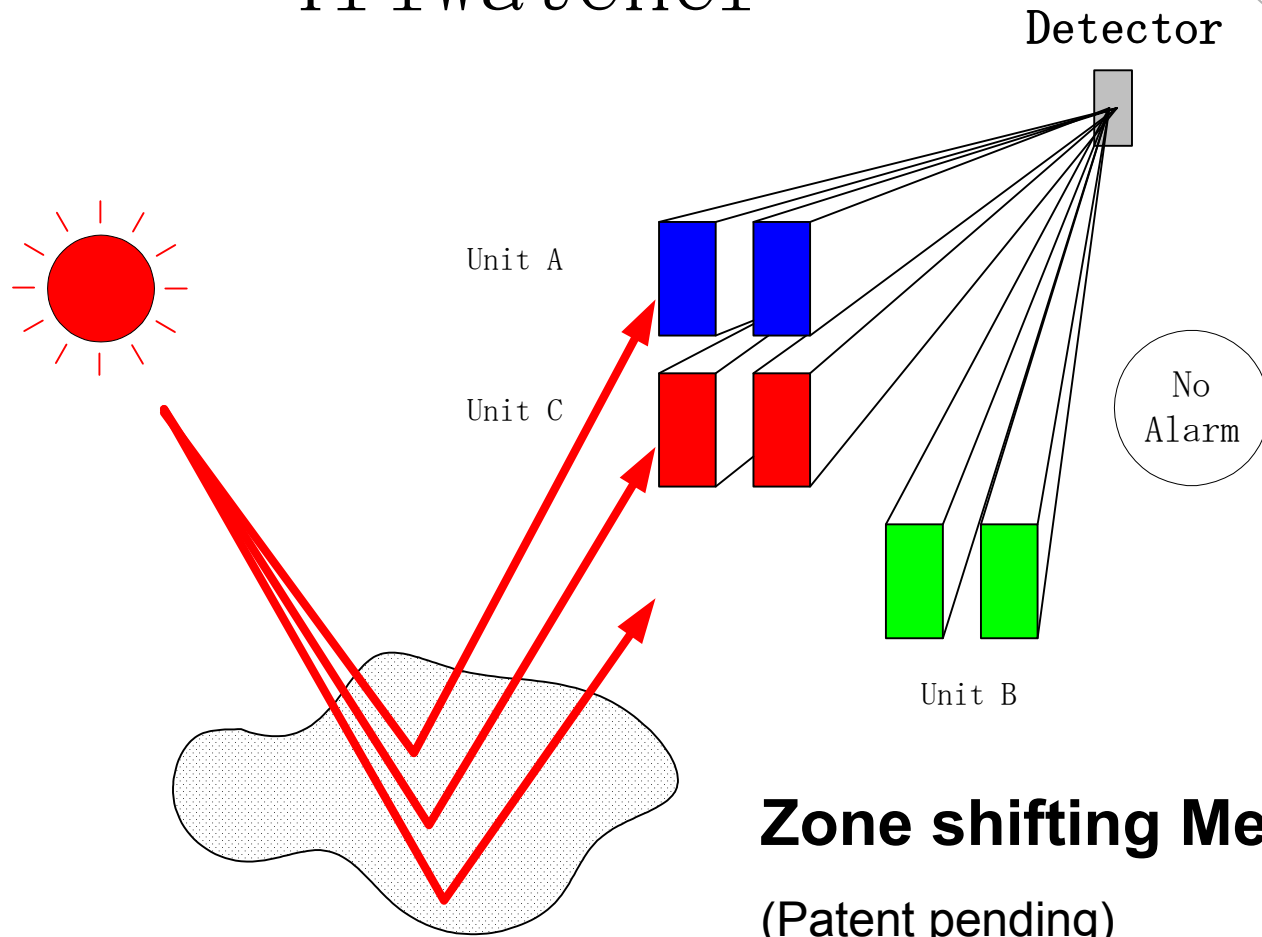

Wide Distance between 3 Units

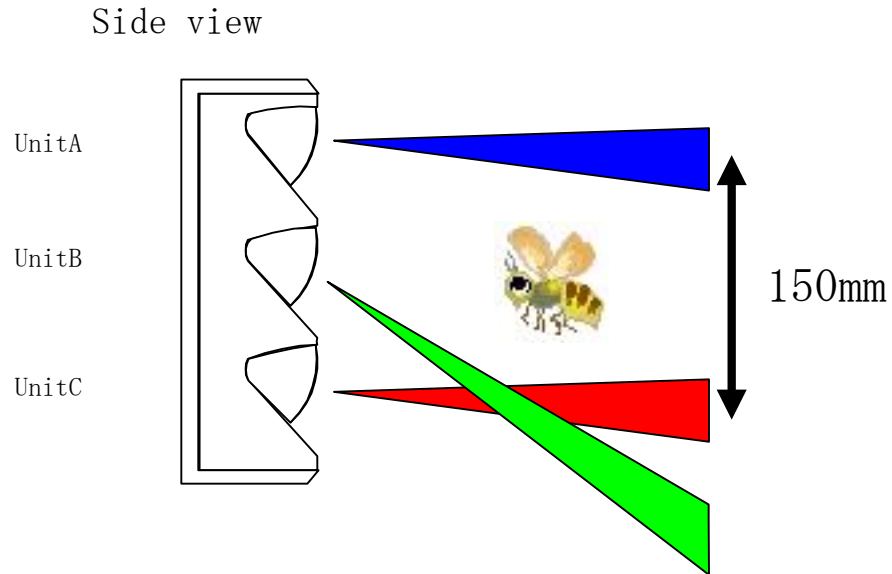
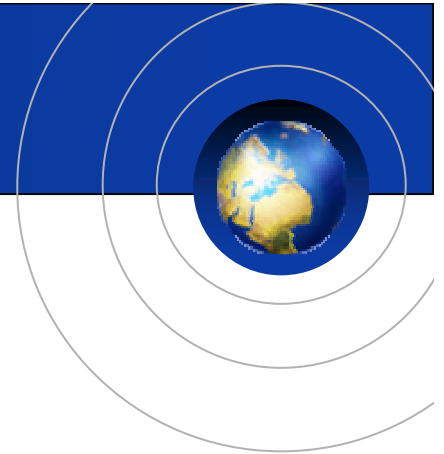

Wide distance between each unit can eliminate False Alarm by Bug, Bird, Leaf and others on the face or close of Detector.

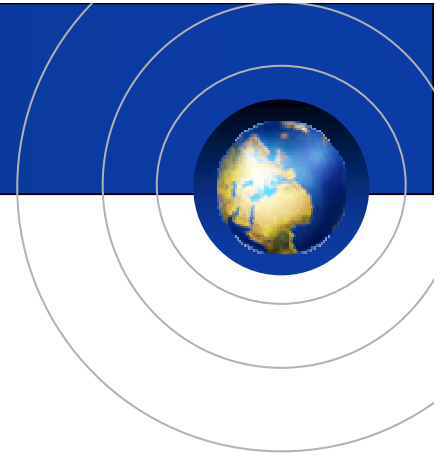

Wide Area Setting 1

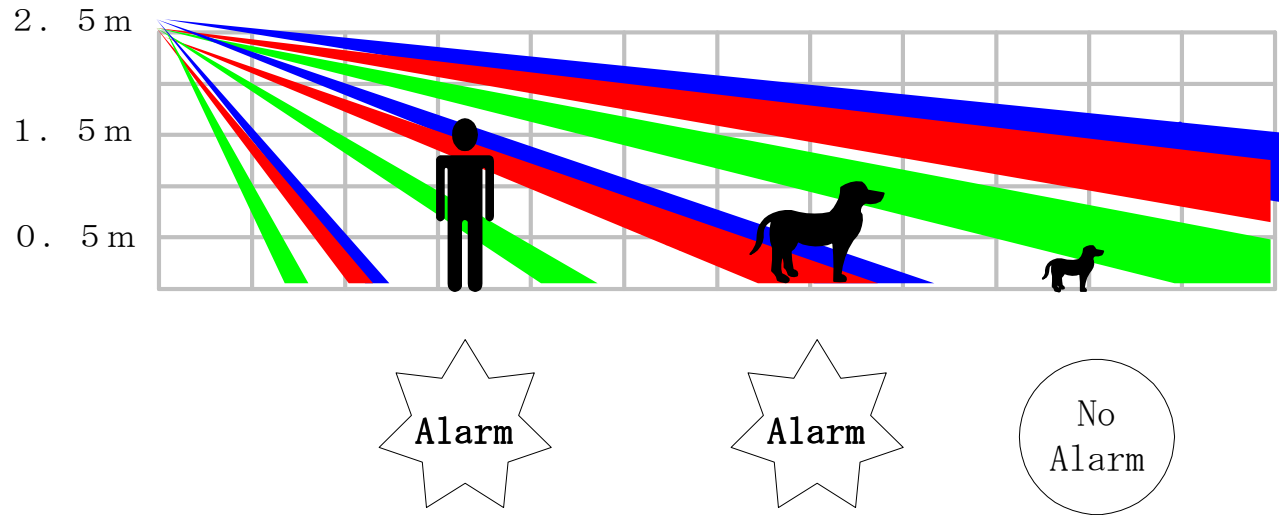

Small Animal No Detection !!!

Animal Immunity ② (Wide Angle)

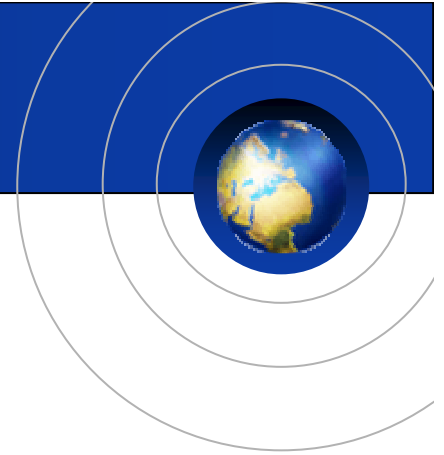

Wide Area Setting 2

Detectoin Zone At Short Distance from Detector

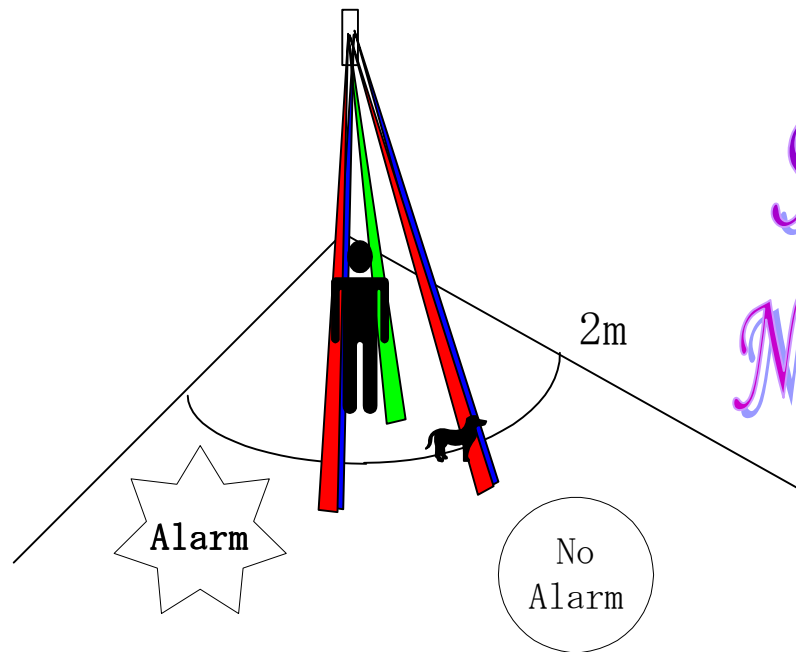

*Small Animal
No Detection !!!!*

Animal Immunity (Pet Alley)

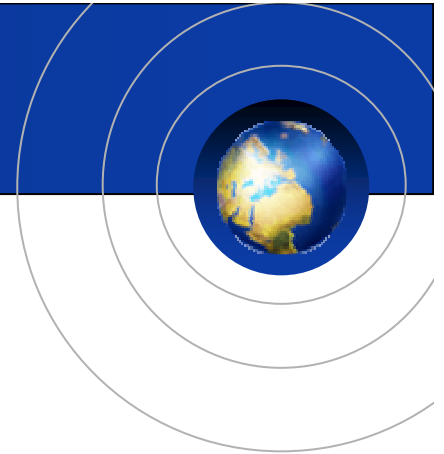

Pet Alley Setting (Animal immunity)

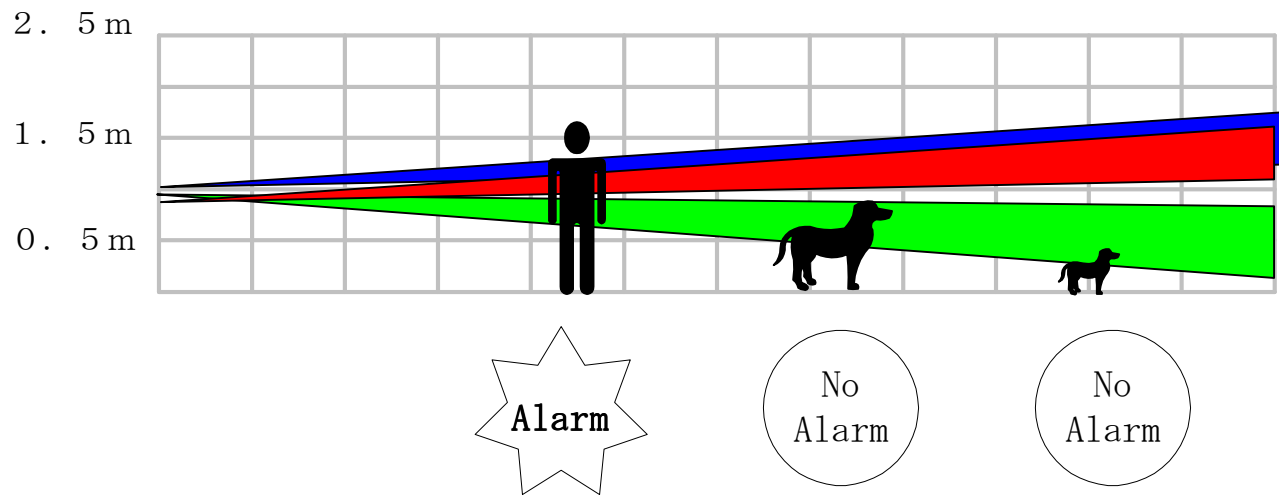

No Animal Detection

Detection Area Adjustment (Range)

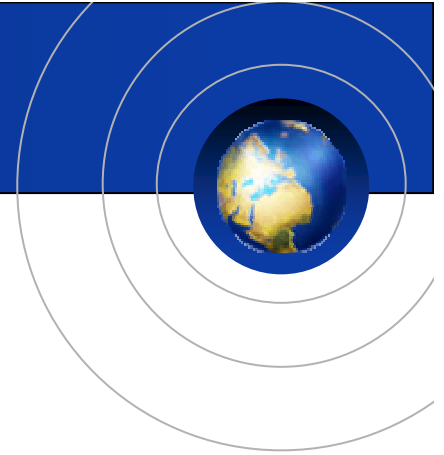

Wide Area Range Adjustment

Long Distance Setting 2.5m Height (Specification)

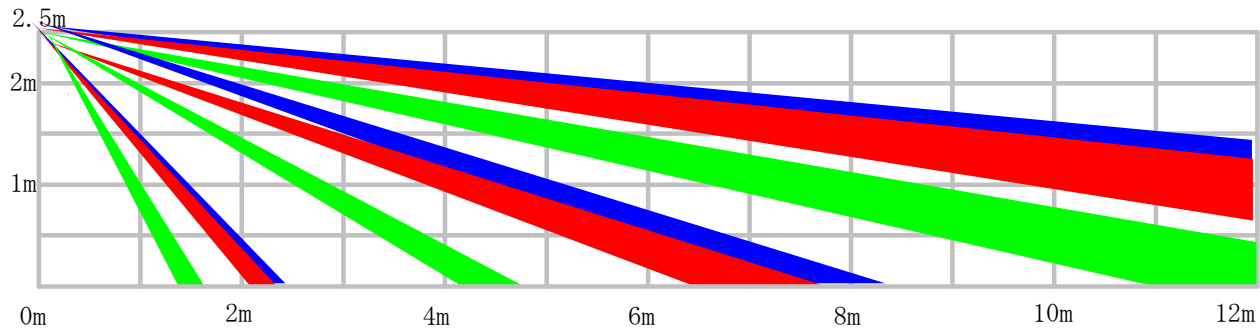

Short Distance Setting 2.5m Height (Specification)

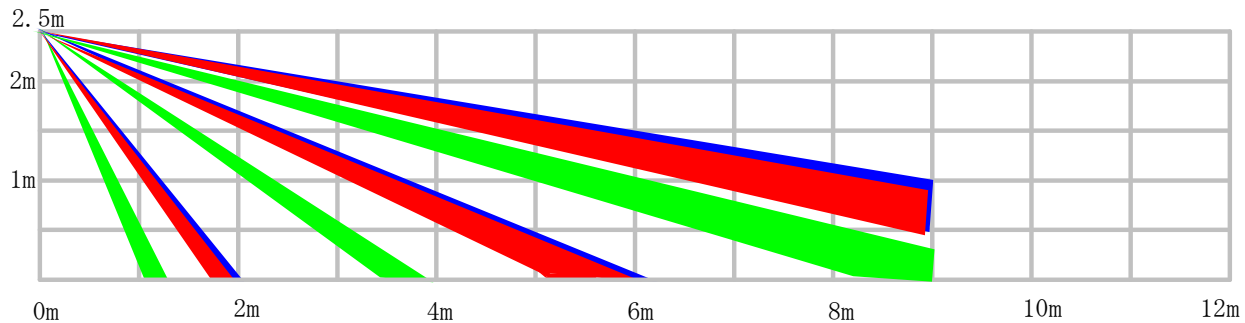

Detection Area Top View

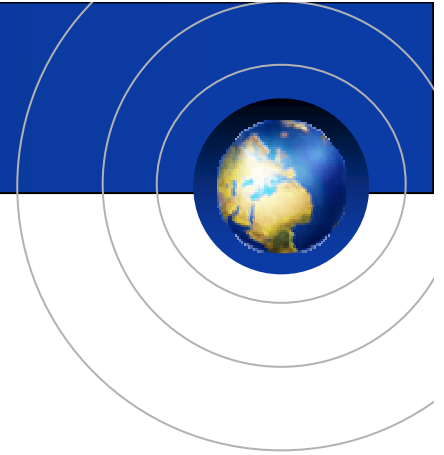

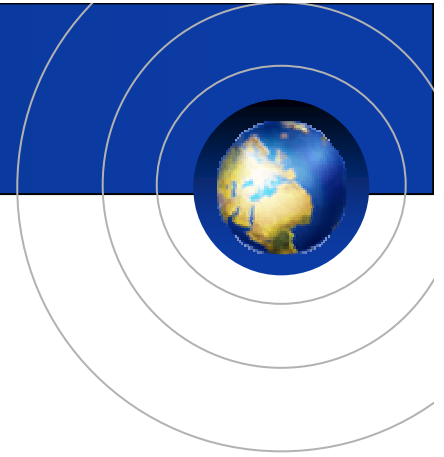

Reference only !!!

At 3.5 m height (exceed Specification 2.5m)

Long Distance Setting 3.5m Height

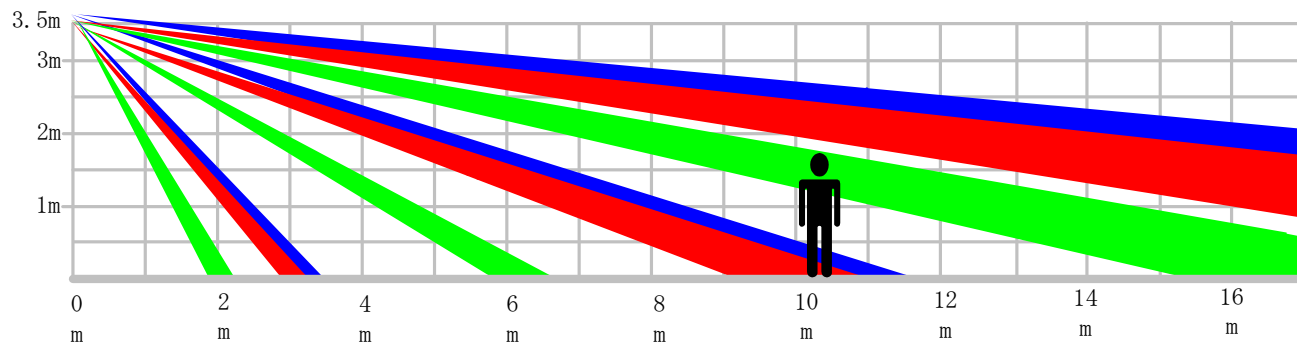

Short Distance Setting 3.5m Height

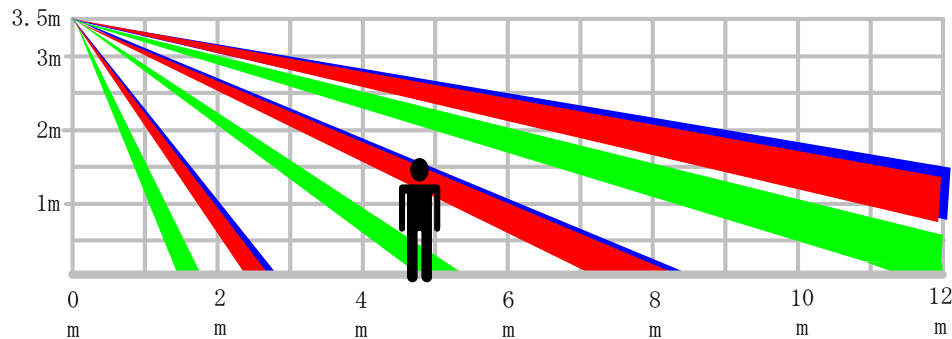

Detection Area Adjustment (Direction)

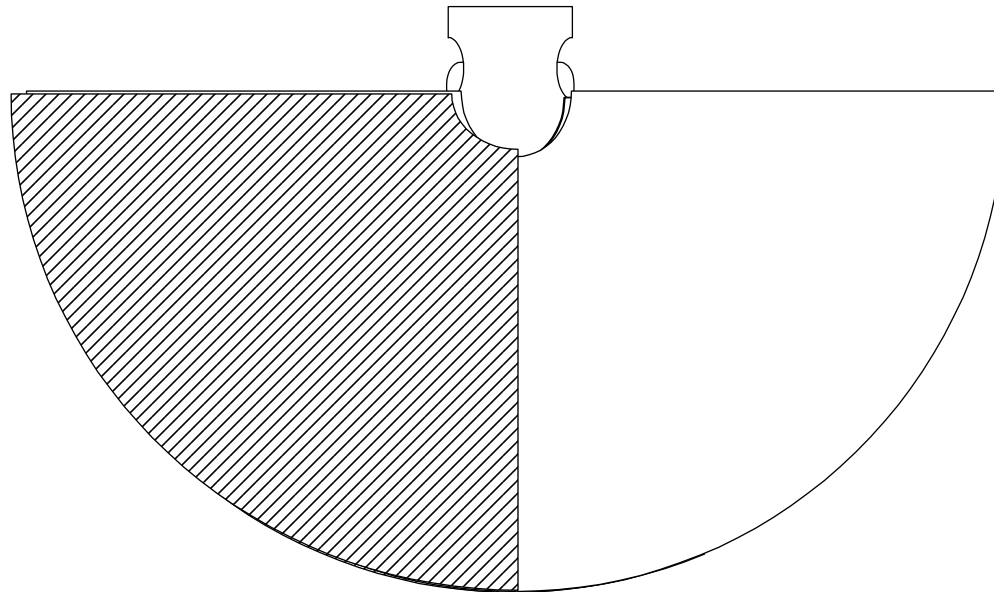
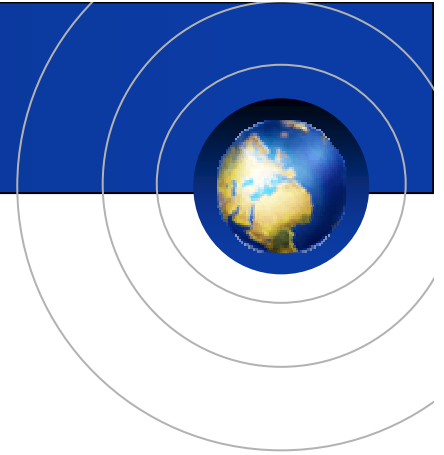

Detection Area is horizontally adjustable $\pm 45^\circ$ by built in structure.

Additional Bracket is not necessary. Therefore Exterior is very nice.

Installation Example

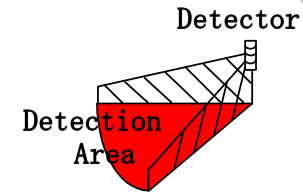
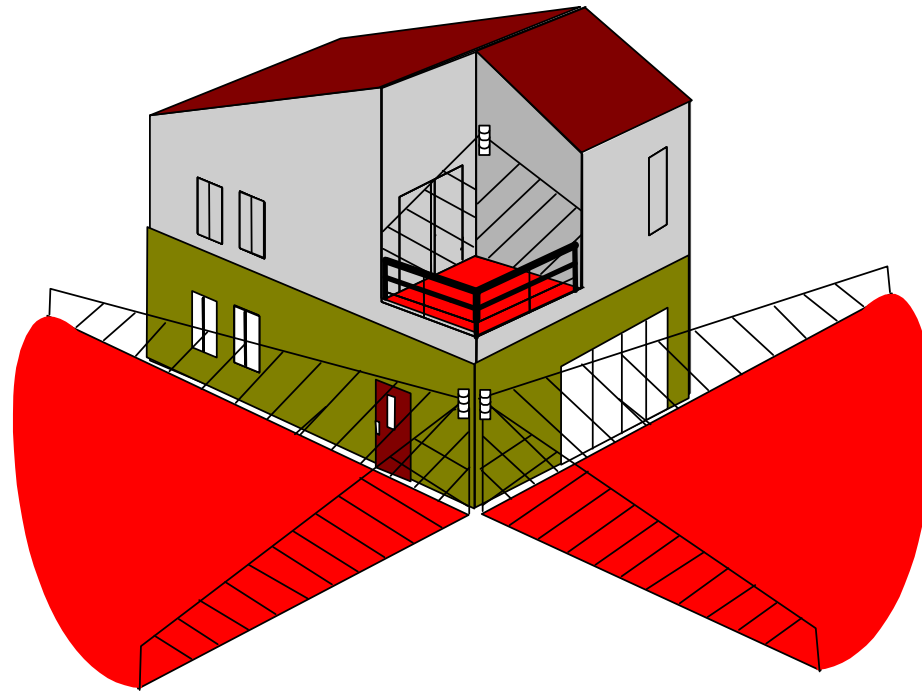
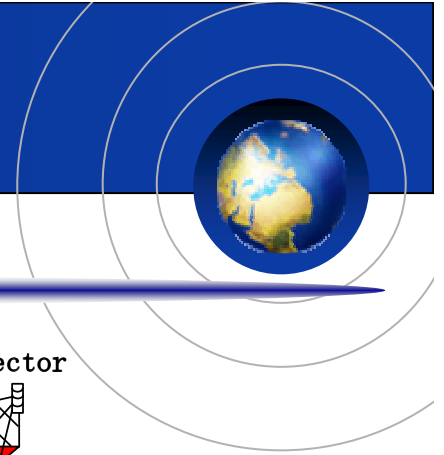

- Wall mount and Pole mount are enable to guard all areas like Garden, Windows, Entrance, Veranda, Periphery and etc.
- Office, Mansion, Factory, Store and etc.

Masking Method 1

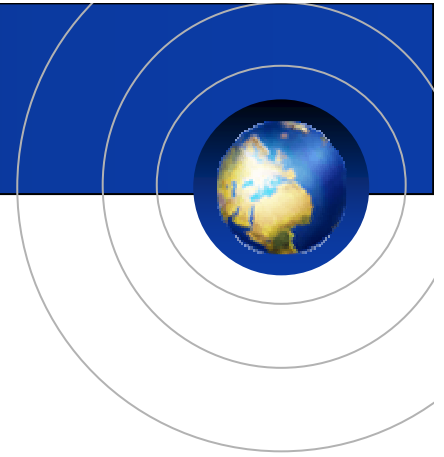

Lens 1

Lens 2

Lens 1

